

SUNBEAM MOTOR CYCLES

"For invincible finish and quality one must
still go to Sunbeams."

"Ixion" in the Motor Cycle.

MAKERS:

JOHN MARSTON LIMITED,
SUNBEAMLAND,
WOLVERHAMPTON.

1927

BARNSTORMERS.CO.NZ

SUNBEAM MOTOR CYCLES

1927

"A reputation for quality is a more valuable asset to a firm or a nation than a short lived success with a low-price article which does not prove satisfactory for any length of time."

The Motor Cycle



Makers:

JOHN MARSTON LIMITED

Head Office and Works:

SUNBEAMLAND · WOLVERHAMPTON · ENGLAND

Telephone: 1481 (4 LINES)

Telegrams & Cables: "SUNBEAM, WOLVERHAMPTON"

Code: A.B.C. 5TH AND 6TH EDITIONS

Service Depôts and Showrooms:

LONDON: 57 Holborn Viaduct, E.C.1 and 157 & 158 Sloane St., S.W.1

MANCHESTER: 20 Peter Street LIVERPOOL: 68 Renshaw Street

BOURNEMOUTH: 203 Old Christchurch Road

BIRMINGHAM: 193 Broad Street

Agents in every large town

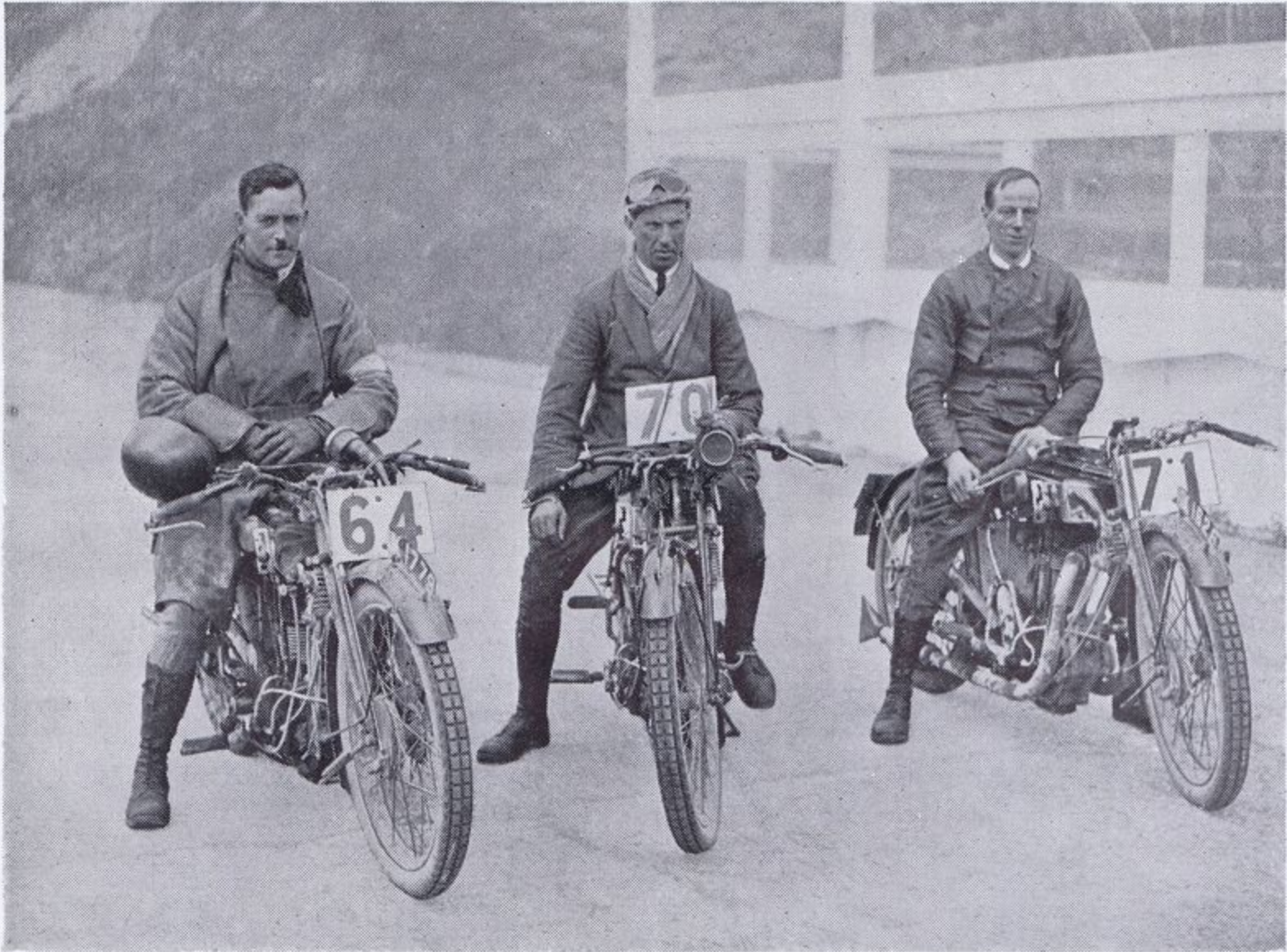

By courtesy of]

[The Motor Cycle

THE SUNBEAM TEAM

Consisting of Messrs. G. W. Walker, Geo. Dance and F. B. Tetstall, who were awarded the Exhibition Medal of the A.C.U. and Team Prize for best performance in the 500 c.c. class of the 1926 International Six Days' Trial.

1927 SUNBEAMS



THERE are many reasons why Sunbeams are the favourites of the motor cycling public. In the first place their design includes many ingenious and exclusive features which contribute not only to the efficiency of the machine but also to the convenience of the rider. These are more fully described on pages 20 to 25, but mention may be made here of the famous Sunbeam "oil-bath" chaincases and the well-known Sunbeam all-black weatherproof finish. These in conjunction provide the advantages that a Sunbeam can be used in any weather without coming to harm; that it need not be cleaned until a convenient opportunity occurs; and that even then a damp sponge will restore the machine to its original beauty. Other features appearing on certain models are the incorporated shock-absorbers and steering-damper, the patent big-end bearing, the patent grease-loaded push-rods on the O.H.V. models, the adjustable clutch stops and adjustable handlebars. Each of these in its sphere is a very real boon and greatly appreciated by all who know them.

Another reason for the popularity of Sunbeams is their magnificent performance under all conditions. Enclosed with this catalogue is a list of competition successes won

by Sunbeam riders during the past year, and on this and other pages in the catalogue appear photographs of riders who have achieved success on Sunbeam motor cycles all over the world. These events include races at Brooklands, Montlhery, Monza and similar tracks; road races such as the Ulster Grand Prix, the French Bol d'Or, the Hun-

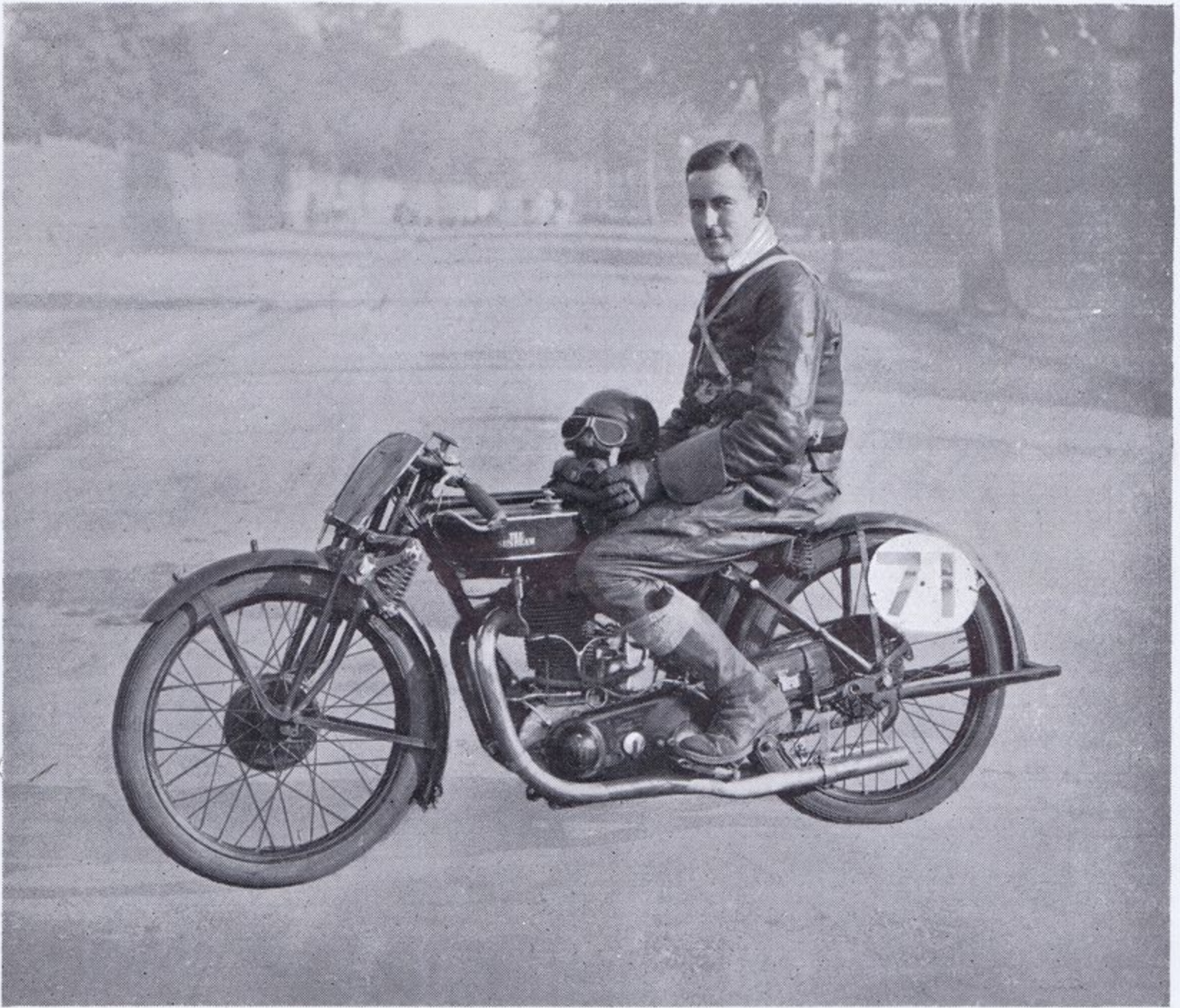

MR. GRAHAM WALKER

Winner of the 500 c.c. Ulster Grand Prix, 600 c.c. Leinster Hundred, etc., and a member of the British International Team.

garian Senior and Junior T.T. Races and the Austrian Open Motor Cycle Derby; reliability trials such as the International and Scottish Six Days, the Arbuthnot Trial and many similar events; the modern extremely severe super-sporting trial of the "scramble" variety such as the

Scott Trial, the Southern Scott Trial and the Lancashire Grand National.

The collection of trophies shown on page 9 must not be taken as representing the total success of Sunbeam riders during the past season. This display only includes a few of the prizes won in the British Isles such as the Arbuthnot

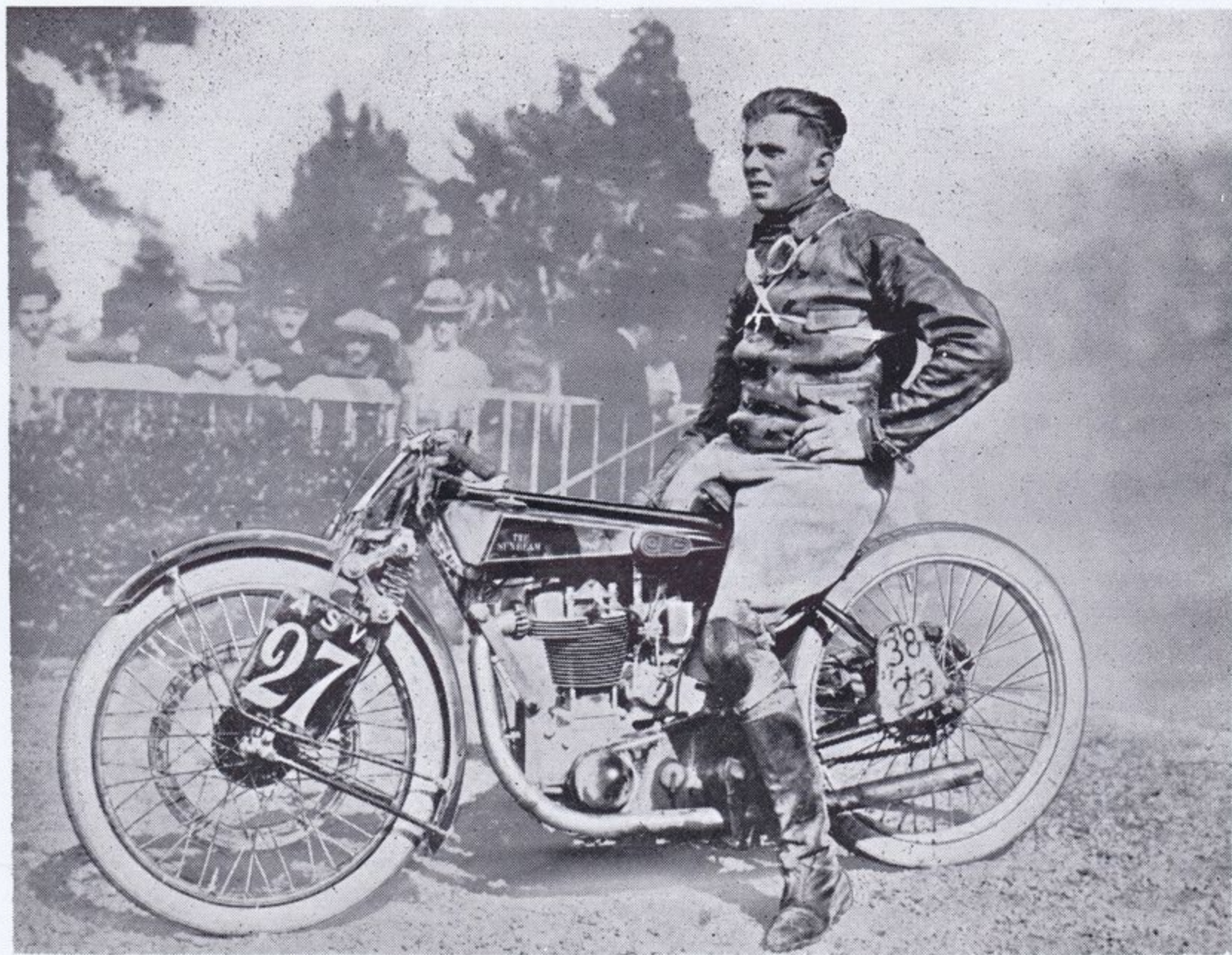

MR. ACHILLE VARZI

Winner of the Grand Prix of Nations (250 miles at 84 m.p.h.) and 500 c.c. Champion of Italy.

Trophy, the Dunlop Trophy, the Alec Ross Trophy, replicas in the T.T. Races and the Manx Amateur Championship, the Robson Shield, the Watson Shield, the Midland Cup, the North Wales Open Challenge Cup, the Ulster Challenge Cup, the Terry Challenge Cup and Terry Golden Goblet, etc. In addition to these there are

many other cups not available for inclusion in the display, besides a host of gold and silver medals and, last but not least, all the array of prizes won outside the British Isles.

Why is it that Sunbeams year after year, although faced by fierce and ever increasing competition, continue to carry off the lion's share of the world's motor cycling events? "Lixion's" words, as given on the cover of this

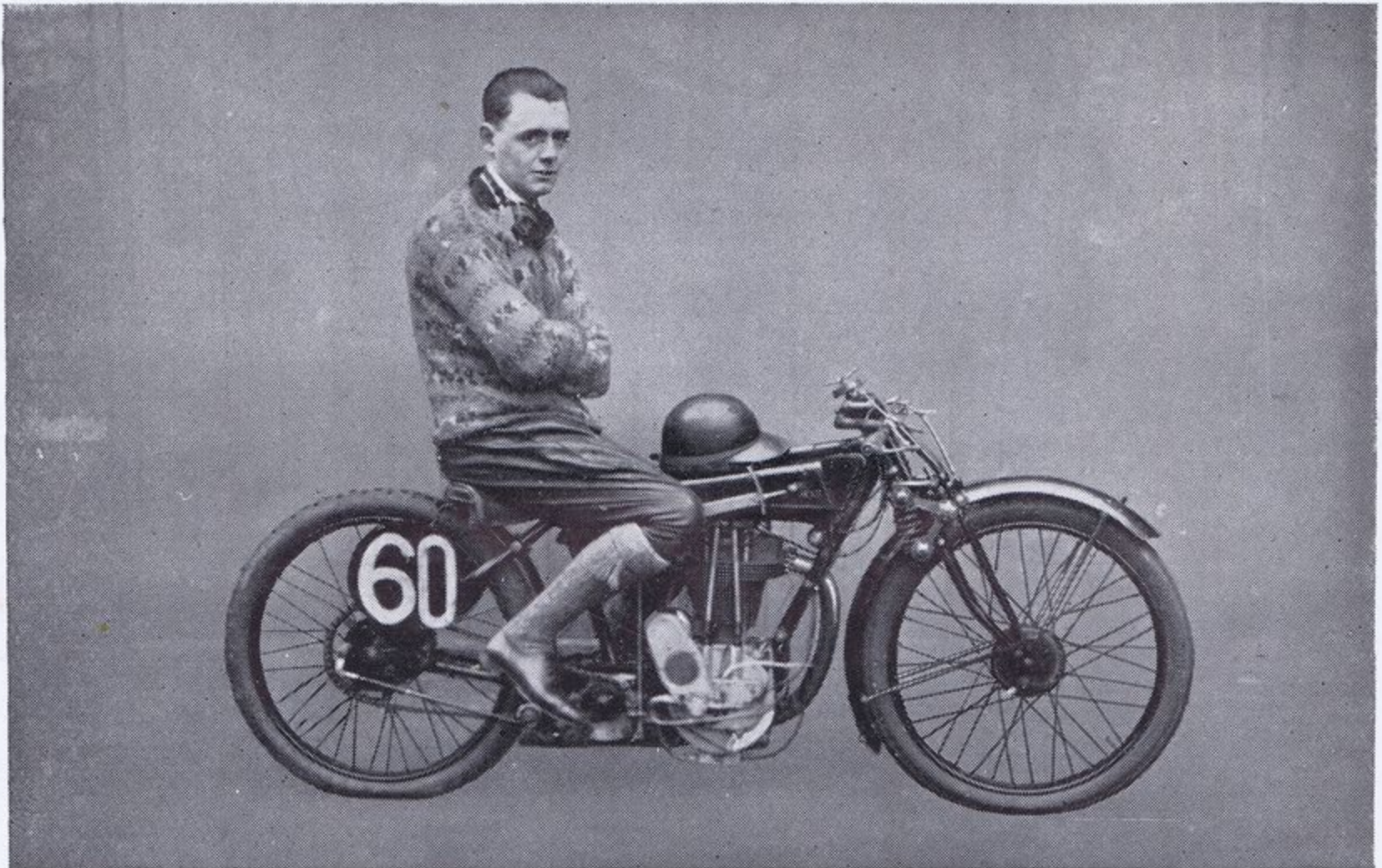

MR. CHARLES WATERHOUSE

A Sunbeam private owner who has obtained 93.99 m.p.h. from his 493 c.c. O.H.V. Sunbeam under Open Competition Rules and Timing.

catalogue, go to the root of the matter and supply the answer. Sunbeams are invincible because of their "invincible finish and quality." It is Sunbeam quality which puts them in a class by themselves and accounts for their remarkable performance, and it is Sunbeam finish, internal as well as external, which enables them to carry on, alike in private hands as in the hands of the professional

rider, in any country, any climate, over any road surface and all the year round. Even those who personally take no interest in racing or trials riding must nevertheless be interested by the very quantity, as well as quality, of the annual Sunbeam harvest. It proves convincingly that a Sunbeam can be purchased in full assurance that it will do anything required of it and will do it well, without fuss and without falter and at a minimum of cost.

There are many different purposes for which a motor cycle may be required, but everyone will find a machine exactly to his taste in the range of Sunbeams for 1927. These are illustrated and fully described on pages 10 to 17 but the following notes may assist the reader to choose the model most suitable for his particular requirements. The Sunbeam sidecars are described on pages 18 and 19.

MODELS 1 and 2. These are respectively touring and sporting models of the 350 c.c. side-valve class. Of absolute reliability, they also show great efficiency and have high powers of acceleration and speed. They are eminently suitable for all-round riding and are capable of taking a light sidecar such as the Sunbeam No. 6 (page 19). They will appeal to all those who do not require the greater horse-power of our larger engines.

MODELS 5 and 6. Magnificent examples of the $3\frac{1}{2}$ h.p. class. Both have the famous Sunbeam "longstroke" engine, Model 5 being supplied with a touring specification and Model 6 as a sporting mount. Unequaled for real hard work and undoubtedly two of the finest motor cycles offered to the public. Although capable of really high speed they are entirely tractable and can be ridden comfortably in any traffic.

MODEL 7 has a $4\frac{1}{4}$ h.p. engine and is intended primarily as a sidecar machine. It has interchangeable wheels, a special leaf-spring front fork, the Sunbeam four-speed gearbox (which cannot be fitted to any other model), leg-shields, enclosed valve springs, etc., and is a

superb example of the highest class. When fitted with sidecar No. 1, it makes a most luxurious combination with wheels detachable and interchangeable to any position. As a guide to its performance it has won a first class award in every A.C.U. Stock Machine Trial for which it has been entered, and has twice won the principal sidecar award in the 1,500 miles German Deutschlandfahrt.

MODEL 9 is a most fascinating machine. It represents exactly what the critical motor cyclist wants. It has the highly efficient 493 c.c. Sunbeam engine with overhead valves, combined with good mud-guarding, comfortable riding position, shock-absorbers incorporated in the front forks, splendid brakes, a guaranteed "Ghost" silencer and every point conducive to enjoyable fast riding. Though capable of very high speeds it is as flexible as a touring model and is in great demand.

MODELS 80 and 90 are pre-eminently road racing machines. They have the Sunbeam two-port O.H.V. engine with "double hair-pin" valve springs, a drop-out rear wheel (which cannot be fitted to Models 1, 2, 5, 6 or 9), incorporated shock-absorbers and steering damper, separate oil tank equipment, the Sunbeam dry sump lubrication system and everything else conducive to high speed. They have had a most successful season: amongst other notable achievements Model 90 won the Grand Prix of Nations at Monza at an average speed of 84 m.p.h. for the 250 miles, whilst Model 80 won the Hungarian Junior T.T. Race and carried the first amateur in the Grand Prix d'Europe. They have been enthusiastically received by press and public alike. The "Irish Cyclist" in reporting the Olympia Show said of them, "The two-port racing machines, of $2\frac{3}{4}$ h.p. and $3\frac{1}{2}$ h.p. respectively, are undoubtedly amongst the very finest models of their class in the Show and represent real value at the prices asked for them."

THE SUNBEAM SIDECARS

The connections are of very simple design and the sidecars can be attached and detached single handed. Nos. 1 and 3 are intended more particularly for use with Model 7 and have a detachable wheel, interchangeable with those on that machine. Nos. 6, 7 and 8 are lighter sidecars and recommended for the other Sunbeams, full particulars of each being given on page 19.

With each new Sunbeam we supply free of charge a complete tool kit (further described on page 25) and a quart tin of Wakefield's Castrol "XL." There is also in the tool-bag a sheet of preliminary instructions and an application form. On receipt of the latter at the works the customer is sent post free by return a copy of the "Sunbeam Motor Cycle Manual" (an instruction book of 68 pages) and instructions for the carburetter and magneto, etc. (and electric lighting when fitted). An extra booklet of supplementary instructions for the O.H.V. Sunbeams is supplied with each of the latter.



A SELECTION OF THE TROPHIES

Won by Sunbeam riders during 1926—all in the British Isles.

The makers reserve the right to make, without notice, such alterations or improvements in any of the specifications given in this catalogue as they may from time to time deem necessary and advisable.

The prices include free delivery within the United Kingdom at the premises of any Sunbeam agent or the nearest railway station.

The Sunbeam guarantee is set out in full on page 28.

The 347 c.c. Touring Side-Valve Sunbeam

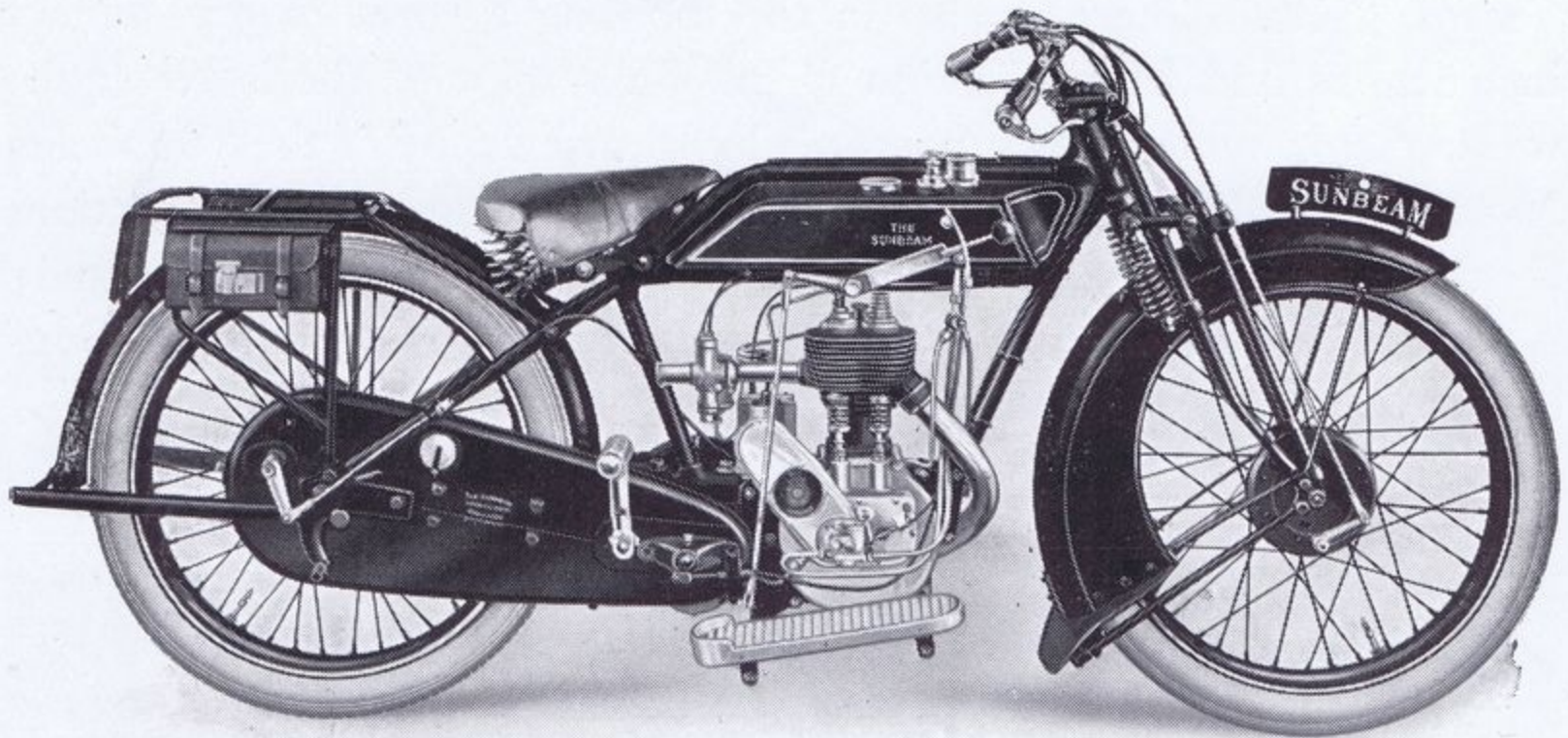

MODEL I

SPECIFICATION FOR 1927

ENGINE Sunbeam single cylinder side-valve, 70 × 90 m/m.
GEARBOX Sunbeam three-speed with enclosed kick-starter.
GEAR RATIOS Standard . . . 5·25, 8·7 and 14·6 Optional . . . 4·9, 8·2 and 13·7 or . . . 5·6, 9·3 and 15·5
BRAKES Sunbeam internal expanding on both wheels.
TRANSMISSION Both chains totally enclosed in Sunbeam patent "oil-bath" chaincases. Sunbeam shock absorber on engine shaft. Sunbeam hand operated clutch. Sunbeam divided rear axle.
TYRES Dunlop 27 in. × 2·75 in. wired-on.
LUBRICATION Mechanical engine lubrication with sight feed. Auxiliary hand pump with two-way tap for lubricating engine or gearbox. Tecaletmit grease gun system for forks.
CARBURETTER Amac. SADDLE . . . Lycett Aero.
SILENCING Large exhaust pipe with "Ghost" silencer.
FOOTBOARDS Rubber covered. Footrests at option of the customer.

SUNBEAM ALL-BLACK WEATHERPROOF FINISH

PRICE IN THE BRITISH ISLES - - - *66 Guineas*

Lucas Magdyno electric lighting outfit, with large size head-lamp and ammeter - extra.

BARNSTORMERS.CO.NZ

£69/6/-

The 347 c.c. Sporting Side-Valve Sunbeam

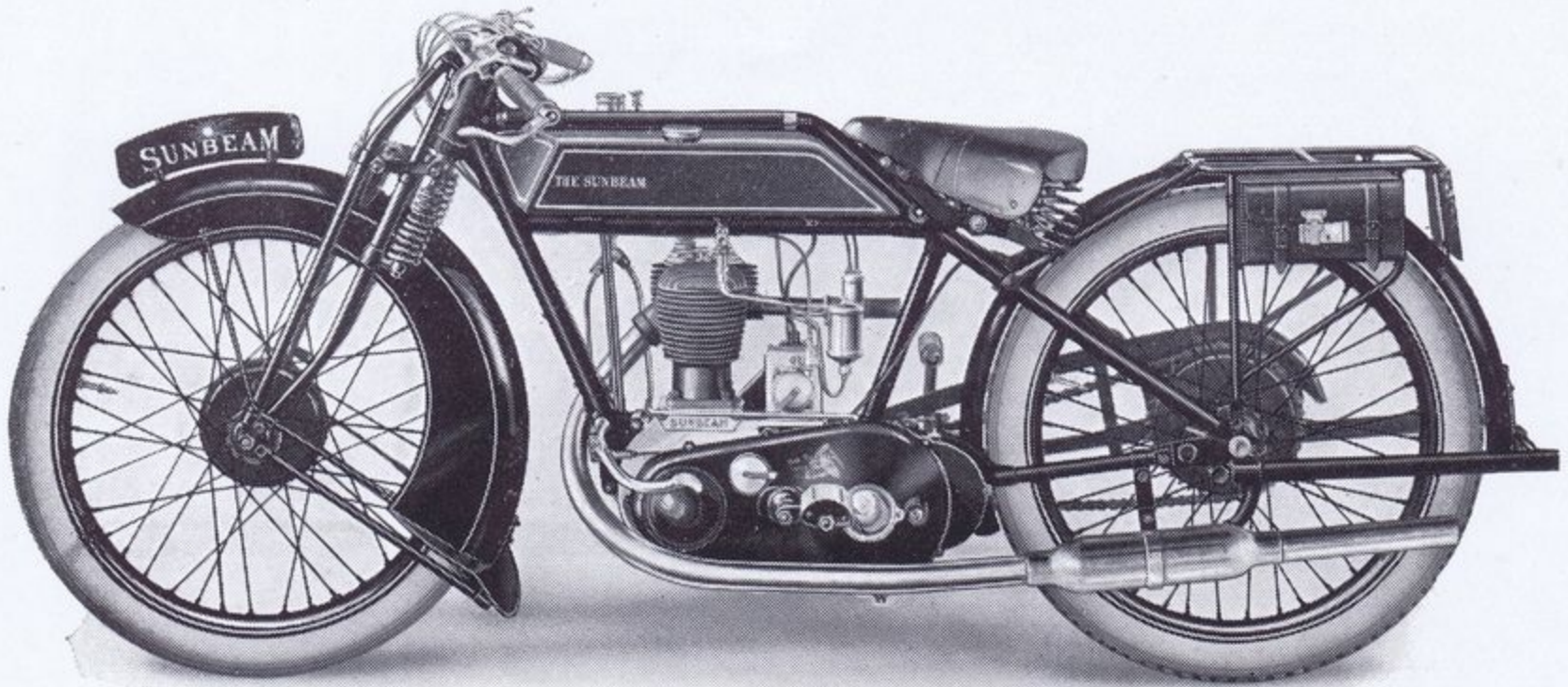

MODEL 2

SPECIFICATION FOR 1927

ENGINE Sunbeam single cylinder side-valve, 70 × 90 m/m.
GEARBOX Sunbeam three-speed with enclosed kick-starter.
GEAR RATIOS Standard . . . 5·25, 8·7 and 14·6 Optional . . . 4·9, 8·2 and 13·7 or . . . 5·6, 9·3 and 15·5
BRAKES Sunbeam internal expanding on both wheels.
TRANSMISSION Front chain totally enclosed in Sunbeam patent "oil-bath" chaincase. Rear chain and brake protected by special chain guard. Sunbeam shock absorber on engine shaft. Sunbeam hand operated clutch. Sunbeam divided rear axle.
TYRES Dunlop 27 in. × 2·75 in. wired-on.
LUBRICATION Mechanical engine lubrication with sight feed. Auxiliary hand pump with two-way tap for lubricating engine or gearbox. Tecaletit grease gun system for forks.
CARBURETTER Amac. SADDLE . . . Lycett Aero.
SILENCING Large exhaust pipe with "Ghost" silencer.
HANDLEBARS Sunbeam underslung pattern; adjustable.

£66/3/-

SUNBEAM ALL-BLACK WEATHERPROOF FINISH

PRICE IN THE BRITISH ISLES - -

63 gns.

Lucas Magdyno electric lighting outfit, with large size head-lamp and ammeter - extra.

BARNSTORMERS.CO.NZ

The 492 c.c. Light Tourist Sunbeam

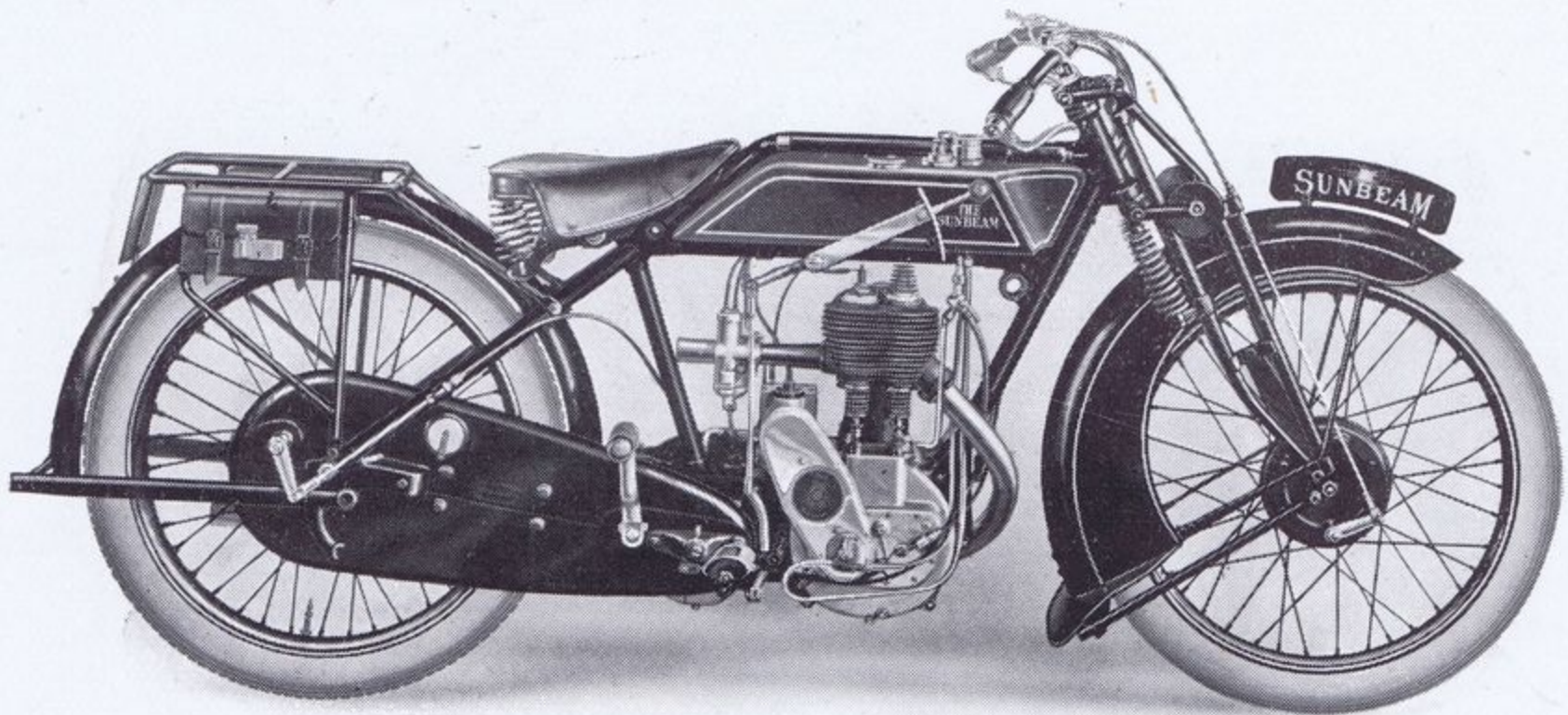

MODEL 5

SPECIFICATION FOR 1927

ENGINE	Sunbeam single cylinder side-valve, 77 × 105.5 m/m.
GEARBOX	Sunbeam three-speed with enclosed kick-starter.
GEAR RATIOS	Standard solo gears . . . 4.6, 7.7 and 13.0 Standard sidecar gears . . . 5.6, 9.3 and 15.5 Optional . . . 4.9, 8.2 and 13.7 or . . . 5.25, 8.7 and 14.6
BRAKES	Sunbeam internal expanding on both wheels.
TRANSMISSION	Both chains totally enclosed in Sunbeam patent "oil-bath" chaincases. Sunbeam shock absorber on engine shaft. Sunbeam hand operated clutch. Sunbeam divided rear axle.
LUBRICATION	Mechanical engine lubrication with sight feed. Auxiliary hand pump with two-way tap for lubricating engine or gearbox. Tecalemit grease gun system for forks.
CARBURETTER	Amac. SADDLE . . . Terry lightweight.
TYRES	Dunlop 27 in. × 2.75 in. wired-on.
SILENCING	Large exhaust pipe with "Ghost" silencer.
FOOTRESTS	Adjustable. Footboards at option of the customer.
SHOCK ABSORBERS	Incorporated in front forks.

SUNBEAM ALL-BLACK WEATHERPROOF FINISH

PRICE IN THE BRITISH ISLES - -

45 gns.

£78/15/-

*Lucas Magdyno electric lighting outfit, with large size head-lamp and
ammeter - extra.*

For suitable sidecars, see page 19

BARNSTORMERS.CO.NZ

The 492 c.c. Longstroke Sunbeam

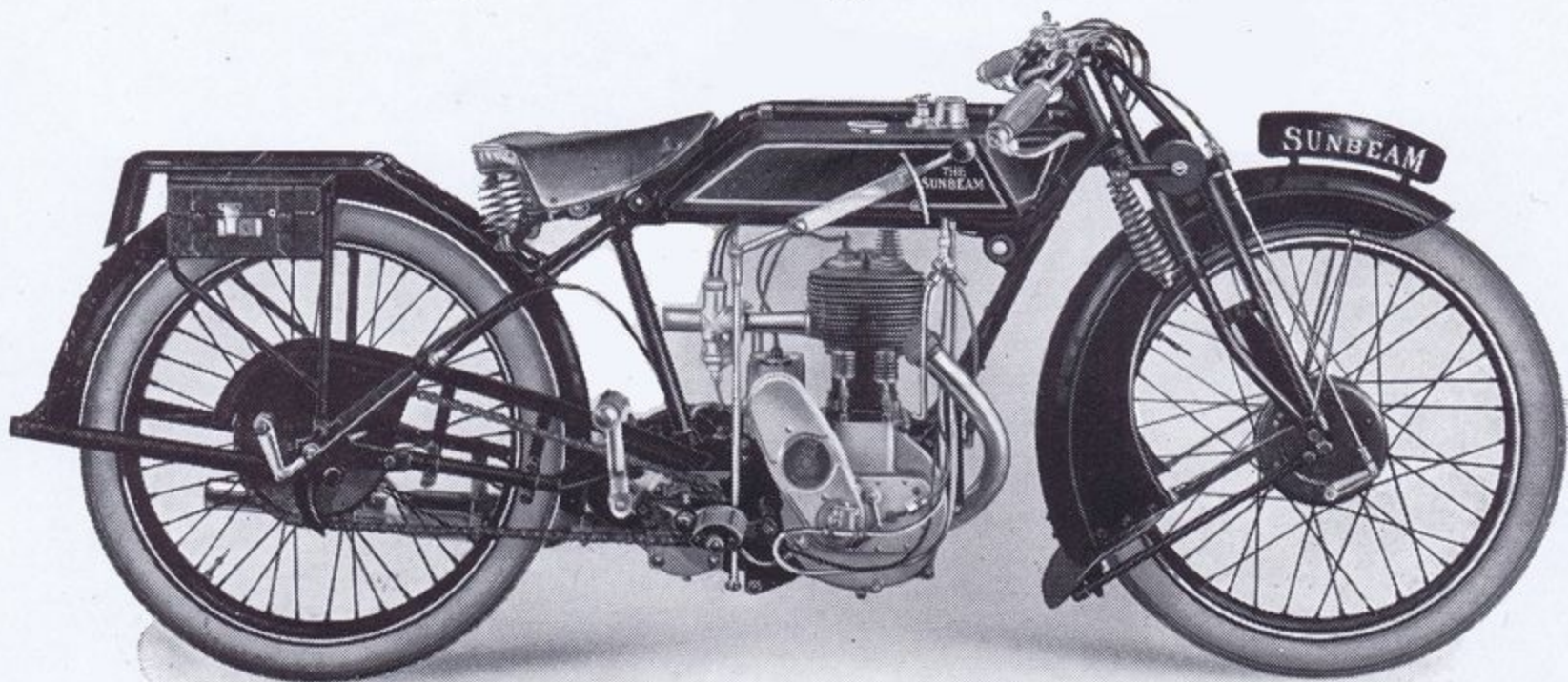

MODEL 6

SPECIFICATION FOR 1927

ENGINE Sunbeam single cylinder side-valve, 77 × 105.5 m/m.
GEARBOX Sunbeam three-speed with enclosed kick-starter.
GEAR RATIOS Standard solo gears . . . 4.3, 6.5 and 9.7 Optional . . . 4.6, 6.9 and 10.3 or . . . 4.9, 7.4 and 11.0
	For sidecar work the following can be supplied to order 5.25, 7.9 and 11.8 or 5.6, 8.4 and 12.6
BRAKES Sunbeam internal expanding on both wheels.
TRANSMISSION Front chain totally enclosed in Sunbeam patent "oil-bath" chaincase. Rear chain and brake pro- tected by special chain guard. Sunbeam shock absorber on engine shaft. Sunbeam hand operated clutch. Sunbeam divided rear axle.
LUBRICATION Mechanical engine lubrication with sight feed. Auxiliary hand pump with two-way tap for lubricating engine or gearbox. Tecalemit grease gun system for forks.
CARBURETTER Amac. SADDLE - Terry lightweight.
TYRES Dunlop 27 in. × 2.75 in. wired-on.
SILENCING Large exhaust pipe with "Ghost" silencer.
SHOCK ABSORBERS Incorporated in front forks.
HANDLEBARS Sunbeam underslung pattern; adjustable. Sun- beam steering damper can be fitted for extra.

SUNBEAM ALL-BLACK WEATHERPROOF FINISH

PRICE IN THE BRITISH ISLES - - - *48 gns.* *£75/12/-*
Lucas Magdyno electric lighting outfit, with large size head-lamp and
ammeter - extra.

The 493 c.c. O.H.V. Sunbeam

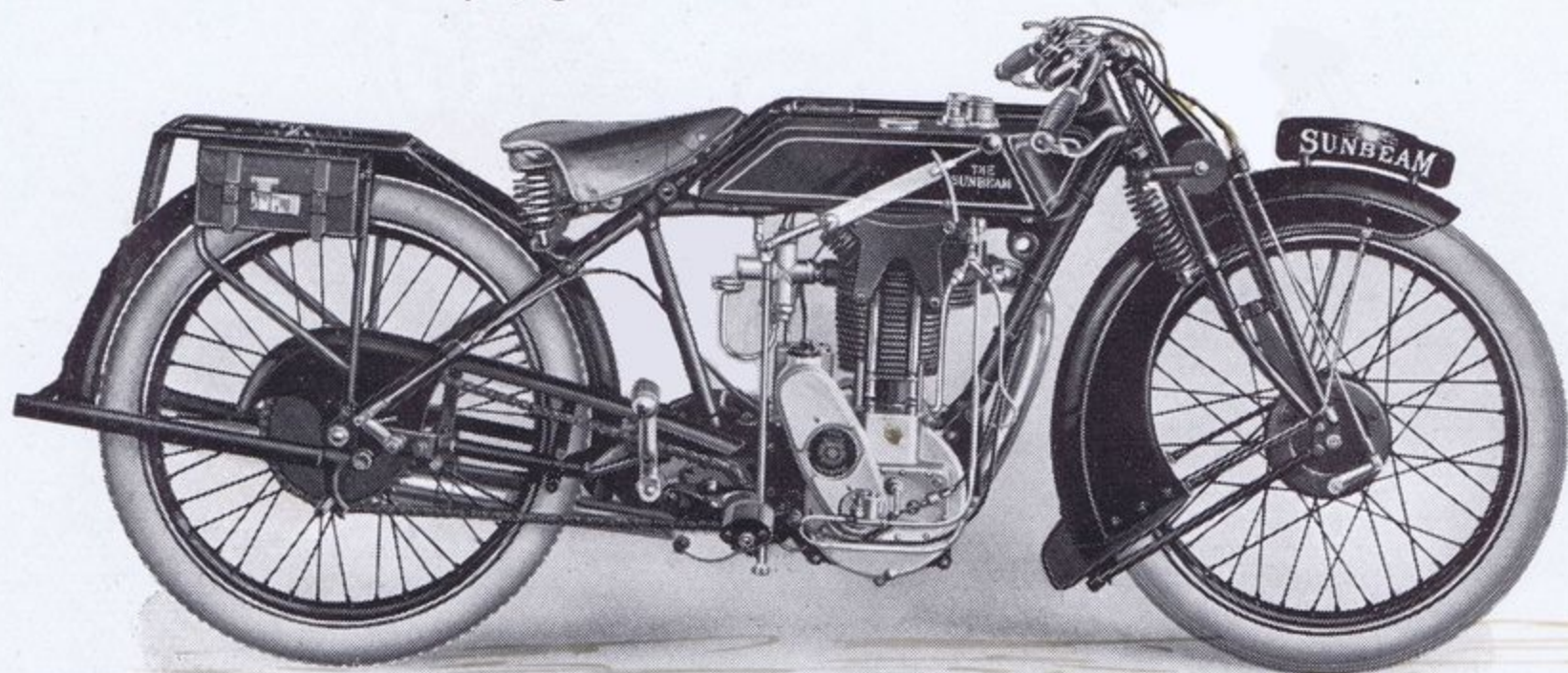

MODEL 9

SPECIFICATION FOR 1927

ENGINE Sunbeam single cylinder single-port O.H.V., 80 × 98 m/m.
GEARBOX Sunbeam three-speed with enclosed kick-starter.
GEAR RATIOS Standard solo gears . . . 4.3, 6.5 and 9.7 Optional . . . 4.6, 6.9 and 10.3 or . . . 4.9, 7.4 and 11.0 For sidecar work . . . 5.25, 7.9 and 11.8 or . . . 5.6, 8.4 and 12.6
BRAKES Sunbeam internal expanding on both wheels.
TRANSMISSION Front chain totally enclosed in Sunbeam patent "oil-bath" chaincase. Rear chain and brake protected by special chain guard. Sunbeam shock absorber on engine shaft. Sunbeam hand operated clutch. Sunbeam divided rear axle.
LUBRICATION Mechanical engine lubrication with sight feed. Auxiliary hand pump with two-way tap for lubricating engine or gearbox. Tecalemit grease gun system for forks.
CARBURETTER Amac. SADDLE . . . Terry lightweight.
TYRES Dunlop 27 in. × 2.75 in. wired-on.
SILENCING Large exhaust pipe with "Ghost" silencer.
SHOCK ABSORBERS Incorporated in front forks.
HANDLEBARS Sunbeam underslung pattern; adjustable. Sun- beam steering damper can be fitted for extra.

SUNBEAM ALL-BLACK WEATHERPROOF FINISH

PRICE IN THE BRITISH ISLES - - - 75 gns. £72/15/-
Lucas Magdyno electric lighting outfit, with large size head-lamp and
ammeter - - - extra.

For suitable sidecars, see page 19

BARNSTORMERS.CO.NZ

The 599 c.c. Four-speed Sunbeam

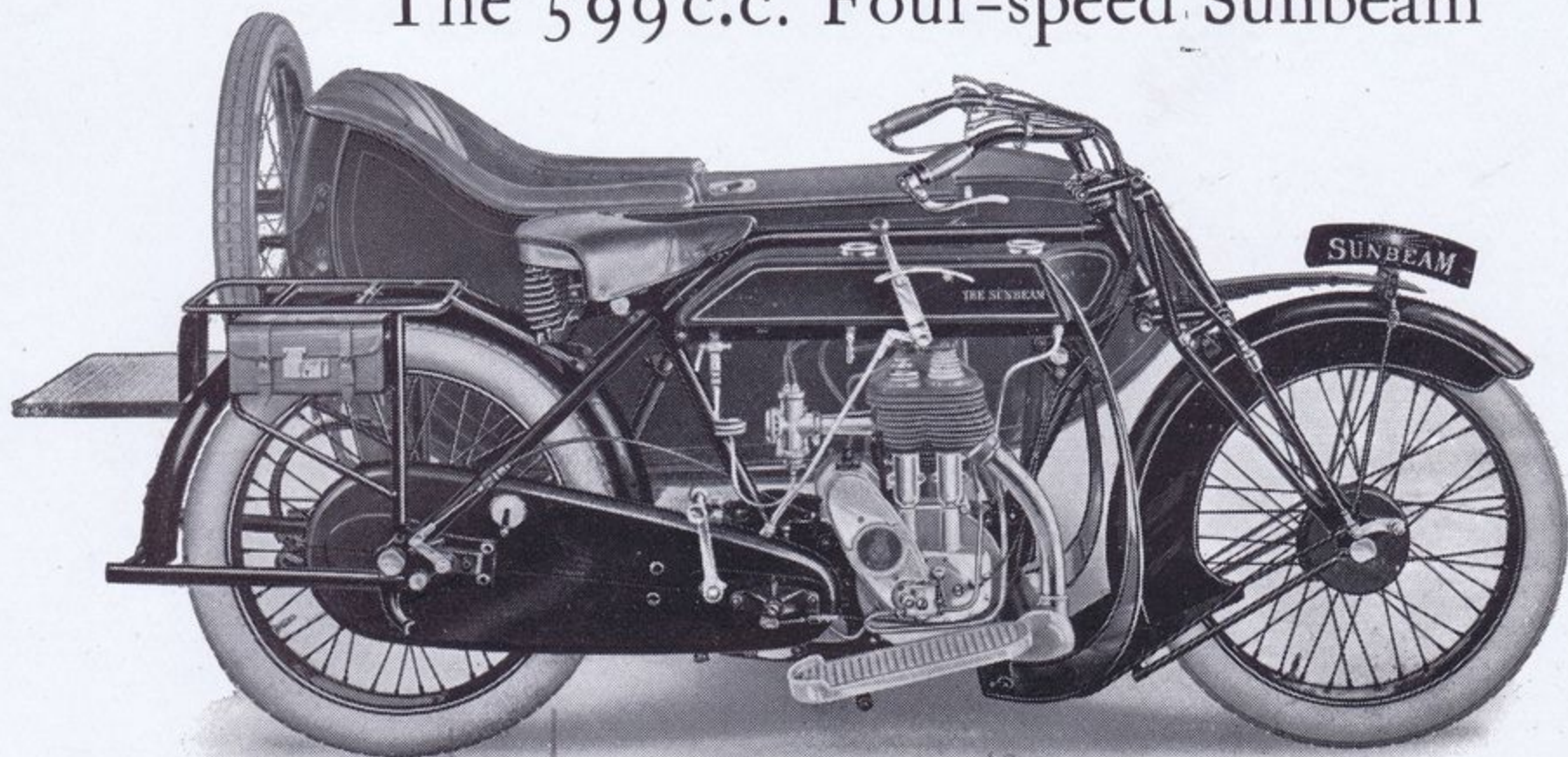

MODEL 7

SPECIFICATION FOR 1927

ENGINE Sunbeam single cylinder side-valve, 85 × 105.5 m/m. Valve stems enclosed in Sunbeam valve covers.
GEARBOX Sunbeam four-speed with enclosed kick-starter.
GEAR RATIOS Double purpose gears . 4.9, 6.6, 9.4 and 14.8 Standard sidecar gears . 5.25, 7.0, 10.0 and 15.7 For hilly districts . 5.6, 7.5, 10.7 and 16.8
BRAKES Sunbeam internal expanding on both wheels.
TRANSMISSION Both chains totally enclosed in Sunbeam patent "oil-bath" chaincases. Sunbeam shock absorber on engine shaft. Sunbeam hand operated clutch.
TYRES Dunlop 26in. × 3.5in. reinforced balloon tyres with Sunbeam detachable and interchangeable wheels.
LUBRICATION Mechanical engine lubrication with sight feed. Auxiliary hand pump with two-way tap for lubricating engine or gearbox. Tecalemit grease gun system for forks.
FRONT FORKS Sunbeam patent leaf-spring suspension.
CARBURETTER Amac. SADDLE . Terry or Lycett heavyweight.
SILENCING Large silencer with tailpipe to rear of machine.
FOOTBOARDS Rubber covered with Sunbeam legshields.

SUNBEAM ALL-BLACK WEATHERPROOF FINISH

PRICE IN THE BRITISH ISLES - *90 gns. £94/10/-* (SIDECAR EXTRA

Extra for Lucas Magdyno electric lighting outfit, with large size head-lamp and ammeter: solo, *with sidecar,*

For suitable sidecars, see page 18

BARNSTORMERS.CO.NZ

The 347 c.c. "T.T." O.H.V. Sunbeam

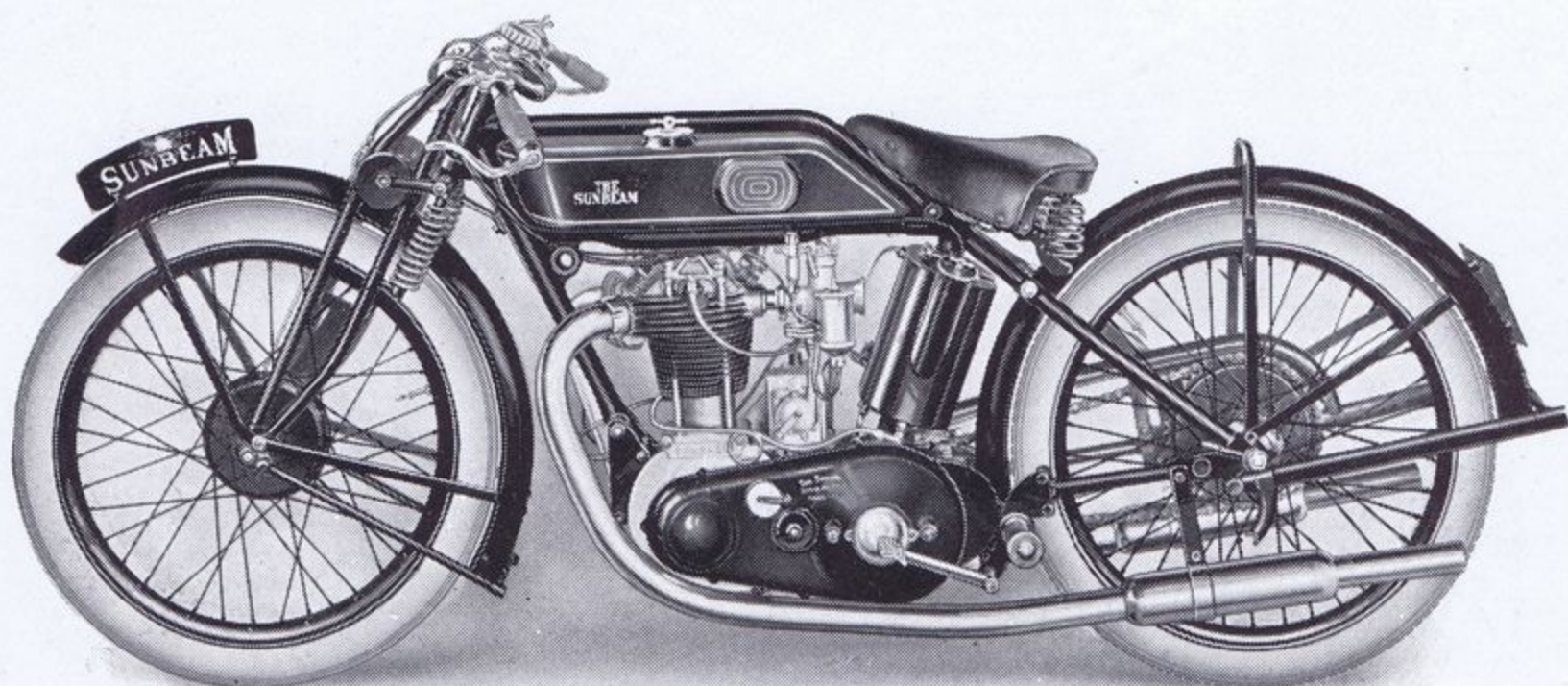

MODEL 80

SPECIFICATION FOR 1927

ENGINE Sunbeam single cylinder two-port O.H.V., 70×90 m/m., with Sunbeam patent "double-hairpin" valve springs (Pat. No. 259870).
GEARBOX Sunbeam three-speed. Footrests either in back racing position with no kick-starter or as on Model 9 with kick-starter at option of customer.
GEAR RATIOS Standard, 4·9, 7·4 and 11·0. Optional, 4·6, 7·0 and 10·5; or 5·25, 7·9 and 11·8; or 5·6, 8·4 and 12·6.
BRAKES Sunbeam internal expanding on both wheels. Rear brake pedal for each foot. (Only for left foot if kick-starter fitted.)
TRANSMISSION Front chain totally enclosed in Sunbeam patent "oil-bath" chaincase. Rear chain and brake protected by special chain guard. Sunbeam shock absorber on engine shaft. Sunbeam hand operated clutch.
TYRES Dunlop 27 in. × 2·75 in. wired-on with Sunbeam "drop-out" rear wheel.
LUBRICATION Sunbeam dry sump lubrication system with Sunbeam mechanical oil pump. Auxiliary oil pump operated from handlebars. Tecaletit grease gun system for forks.
CARBURETTER Amac. SADDLE . Terry lightweight.
FUEL CAPACITY Petrol, 2½ gallons. Separate oil tank, ¾ gallon.
SHOCK ABSORBERS Incorporated in front forks. Also fitted with Sunbeam steering damper, adjustable while riding.

SUNBEAM ALL-BLACK WEATHERPROOF FINISH

PRICE IN THE BRITISH ISLES - -

90 gns. £94/10/-

For suitable sidecars, see page 19
BARNSTORMERS.CO.NZ

The 493 c.c. "T.T." O.H.V. Sunbeam

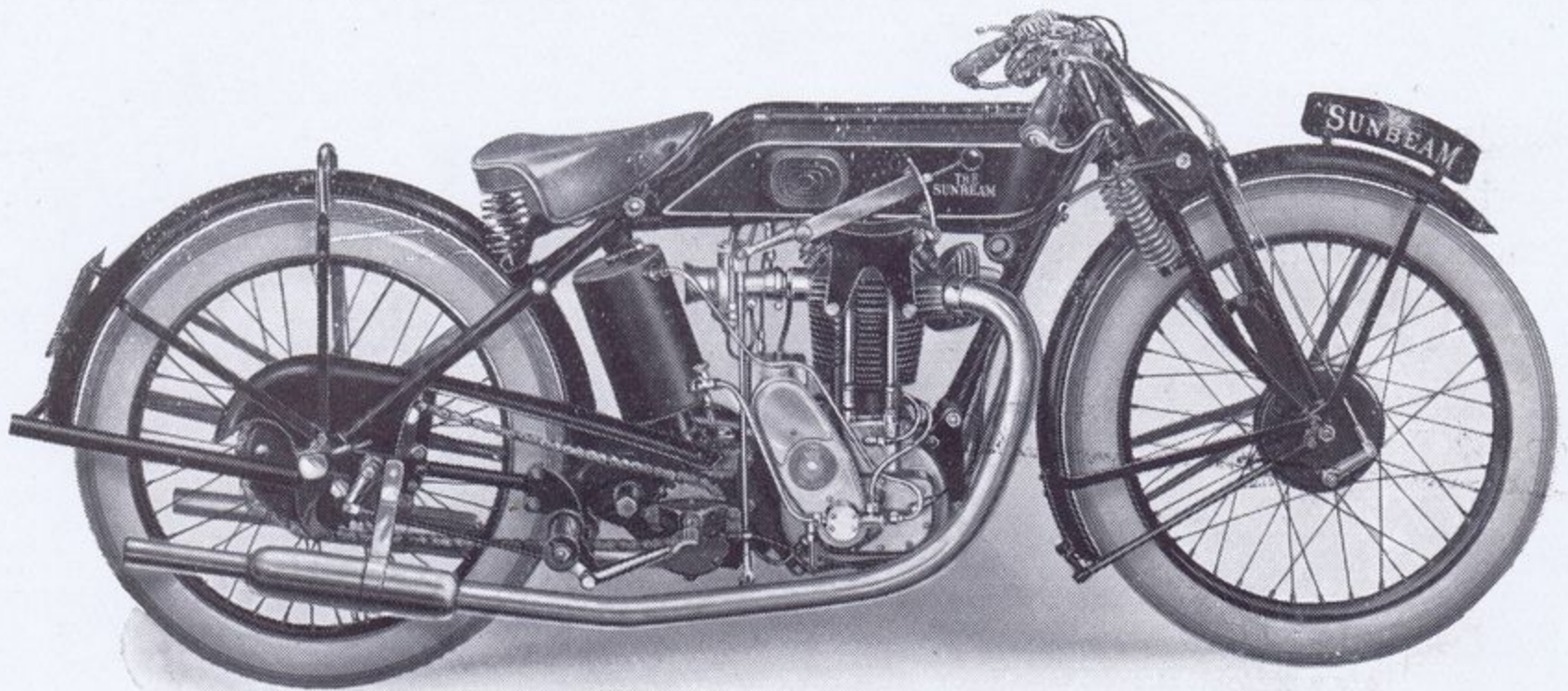

MODEL 90

SPECIFICATION FOR 1927

ENGINE	. . .	Sunbeam single cylinder two-port O.H.V., 80×98 m/m., with Sunbeam patent "double-hairpin" valve springs (Pat. No. 259870).
GEARBOX	. . .	Sunbeam three-speed. Footrests either in back racing position with no kick-starter or as on Model 9 with kick-starter at option of customer.
GEAR RATIOS	. . .	Standard solo gears, 4.3, 6.5 and 9.7. Optional, 4.6, 6.9 and 10.3; or 4.9, 7.4 and 11.0. Sidecar work: 5.25, 7.9 and 11.8; or 5.6, 8.4 and 12.6.
BRAKES	. . .	Sunbeam internal expanding on both wheels. Rear brake pedal for each foot. (Only left foot pedal if kick-starter fitted.)
TRANSMISSION	. . .	Front chain totally enclosed in Sunbeam patent "oil-bath" chaincases. Rear chain and brake protected by special chain guard. Sunbeam shock absorber and hand operated clutch.
TYRES	. . .	Dunlop 27 in. × 2.75 in. wired-on with Sunbeam "drop-out" rear wheel.
LUBRICATION	. . .	Sunbeam dry sump lubrication system with Sunbeam mechanical oil pump. Auxiliary oil pump operated from handlebars. Tecalemit grease gun system for forks.
CARBURETTER	. . .	Amac.
FUEL CAPACITY	. . .	Petrol, 2½ gallons. Separate oil tank, ¾ gallon.
SHOCK ABSORBERS	. . .	Incorporated in front forks. Also fitted with Sunbeam steering damper, adjustable while riding.

SUNBEAM ALL-BLACK WEATHERPROOF FINISH

PRICE IN THE BRITISH ISLES

- - 100 gns. £105/-

For suitable sidecars, see page 19

BARNSTORMERS.CO.NZ

THE SUNBEAM SIDECARS

These are a special feature. The connections fit lugs in the frame of the motor cycle; consequently the alignment is not lost when the sidecar is detached. The following range will be found to offer a sidecar for every purpose.

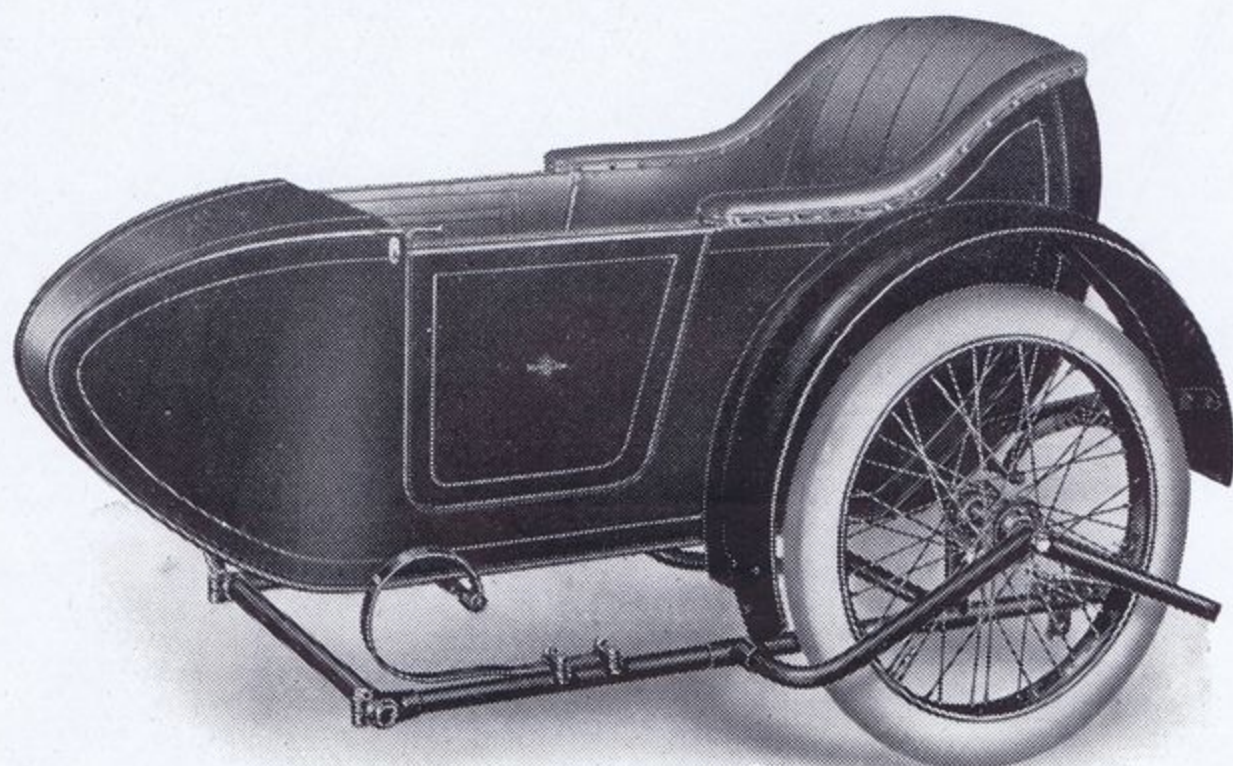

No. 1

SUNBEAM SIDECAR No. 1. For use with Model 7. Wheel is detachable and interchangeable and fitted with Dunlop 26 in. \times 3.5 in. reinforced balloon tyre. Supplied with waterproof apron, fibre mat and sidecar tools.

PRICE IN THE BRITISH ISLES -

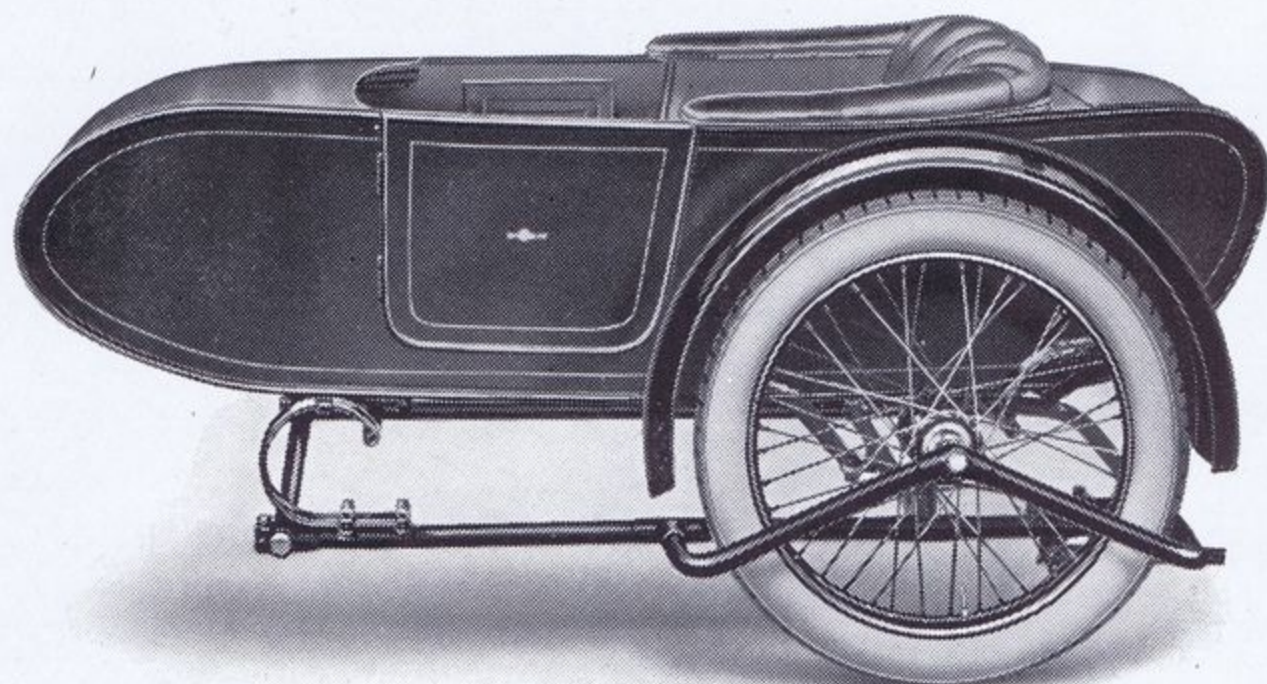

No. 3

SUNBEAM SIDECAR No. 3. Also for use with Model 7. Has the same chassis, wheel, tyre and equipment as Model 1, but the body is on more sporting lines. Large locker behind seat.

PRICE IN THE BRITISH ISLES -

BARNSTORMERS.CO.NZ

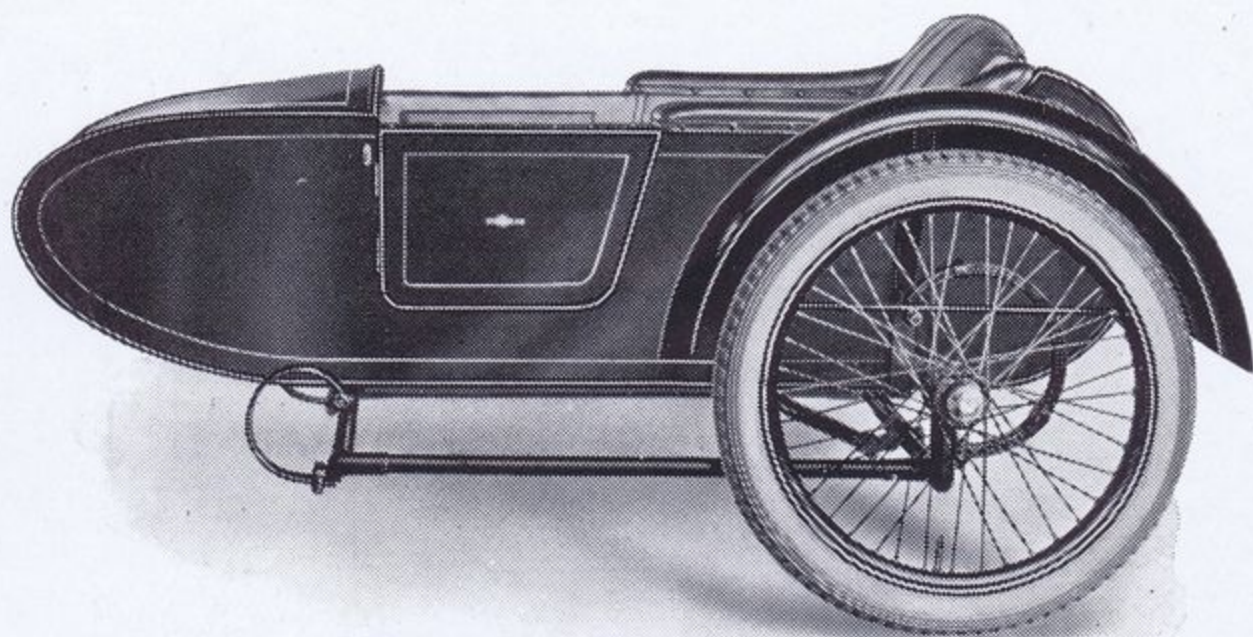

No. 8

SUNBEAM SIDECAR No. 8. Light but well padded and most comfortable. Large luggage space behind seat. A first class touring sidecar. Recommended for Models 5, 6 or 9. Supplied with waterproof apron and Dunlop 27 in. \times 2.75 in. wired-on tyre.

PRICE IN THE BRITISH ISLES -

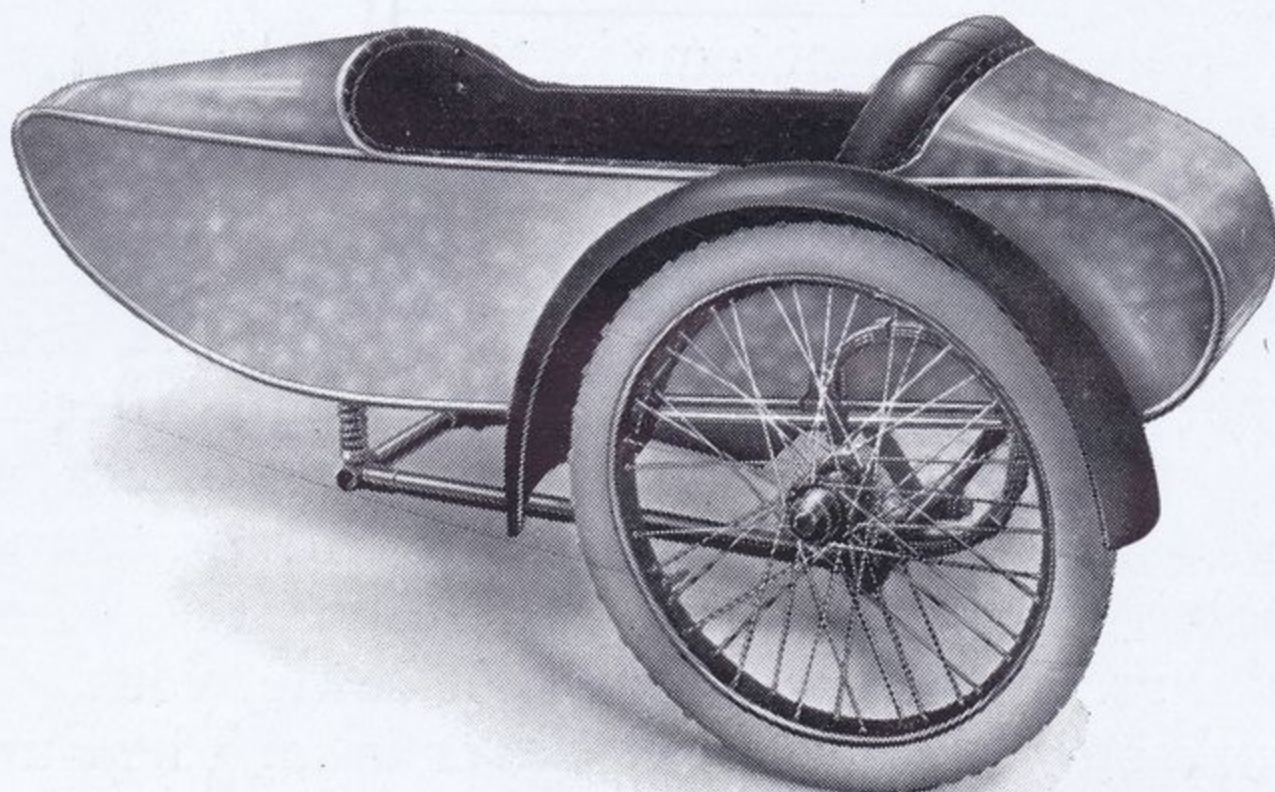

No. 7

SUNBEAM SIDECAR No. 7. A very fine sporting sidecar, finished in frosted aluminium. Recommended for use with Models 5, 6, 9, 80 or 90. With waterproof apron and Dunlop 27 in. \times 2.75 in. wired-on tyre.

PRICE IN THE BRITISH ISLES -

SUNBEAM SIDECAR No. 6. Same chassis, tyre, etc., as No. 7, but finished in black and gold and with door. Recommended for use with Models 1, 2, 5 or 6.

PRICE IN THE BRITISH ISLES -

SIDECAR ACCESSORIES

Spare wheel and brackets for Nos. 1 or 3, with Dunlop balloon tyre
 Luggage grid, as illustrated on page 15
 Easting best quality screen with apron, including fitting
 Easting sporting model ditto, including fitting

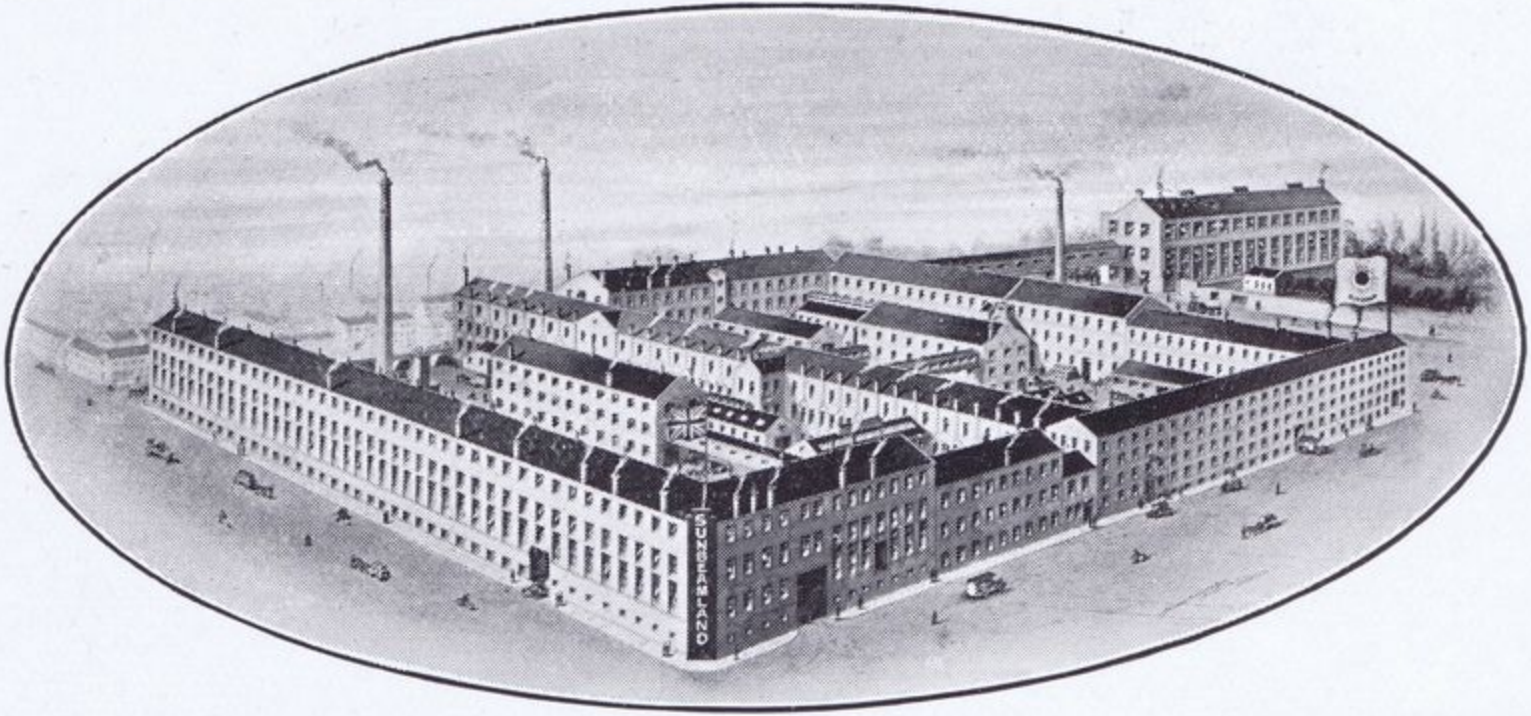

SUNBEAMLAND

SUNBEAM SPECIAL FEATURES

ONE of the greatest problems in motor cycle design is the difficulty of conveying the engine power to the rear wheel without excessive loss. Belts stretch, slip and break. Chains eliminate wastage by slip, but exposed chains deteriorate rapidly because road grit combines with the lubricant and forms a highly destructive grinding compound. The famous Sunbeam patent enclosed "oil-bath" chaincases, found on Sunbeams only, solve this problem completely. The cases are oil-retaining, gritproof and do not rattle, yet are easily detachable should the necessity ever arise. The Sunbeam

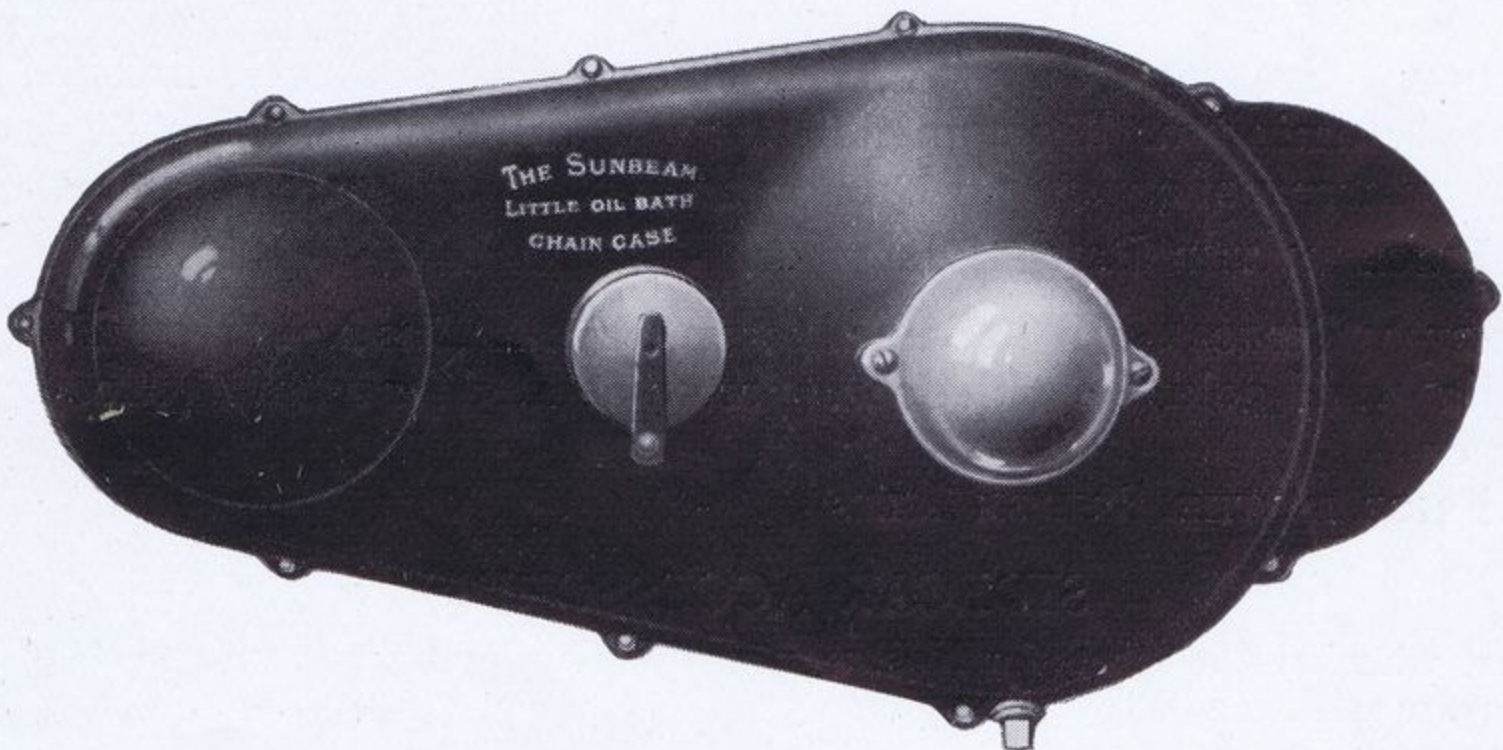

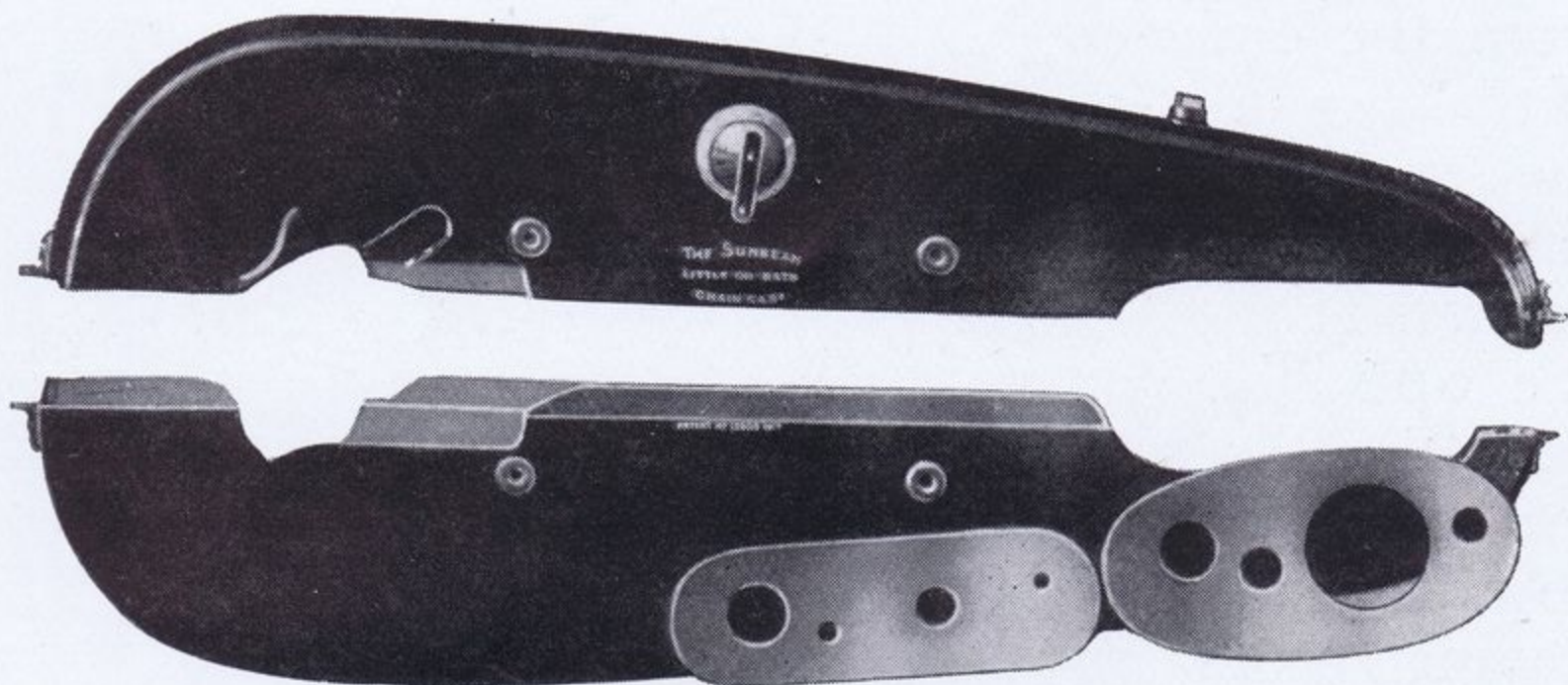

THE SUNBEAM PATENT REAR CHAINCASE

“cush-drive,” a shock-absorbing mechanism on the engine shaft, relieves engine, chains and tyres from undue wear and shock. The whole drive is kept clean and properly lubricated and consequently maintains its efficiency over extremely long distances, besides having the additional advantage that it is equally at its best in all weathers and under all conditions of road surface.

Provision is made for the removal of the rear tyre or tube without disturbing anything else.

Models 1, 2, 5, 6 and 9 are fitted with the ingenious divided rear axle illustrated on page 22. In this clever device the left hand support of the hub consists of a removable bolt. When this is withdrawn a distance piece drops out leaving a gap through which tyre and tube can be withdrawn and replaced without having to take the wheel out of the frame. The adjustment of the hub bearing cannot be disturbed when the device is in use since the setting of this adjustment cannot be altered unless the right hand spindle nut is first loosened.

Models 80 and 90 are fitted with the Sunbeam “drop-out” rear wheel shown on page 22. The operation is extremely simple. The nut and washer are removed

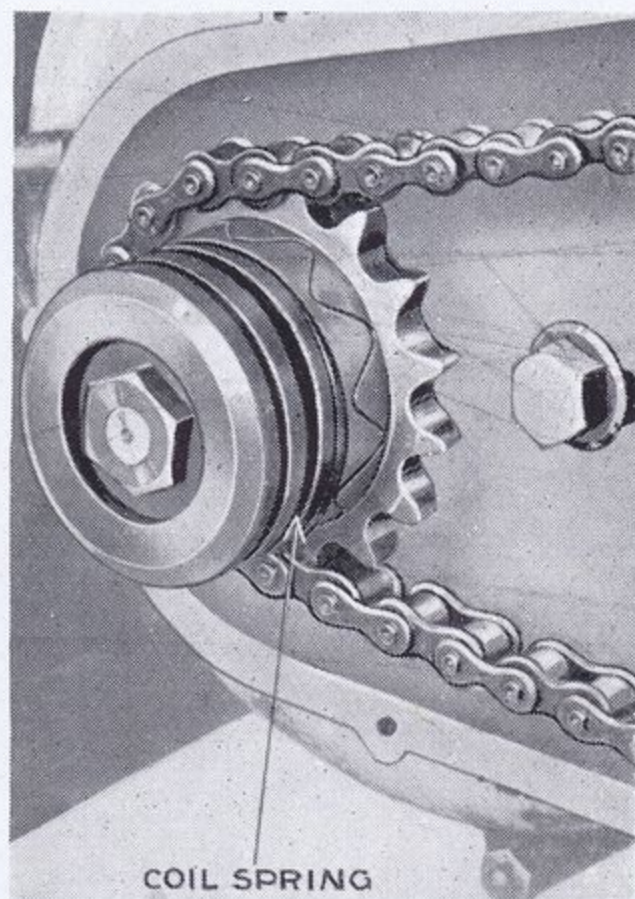

COIL SPRING

THE SUNBEAM PATENT “CUSH-DRIVE”

from the end of the spindle: the spindle is then withdrawn from the opposite end. The distance piece now drops out leaving room for the wheel and hub to be withdrawn

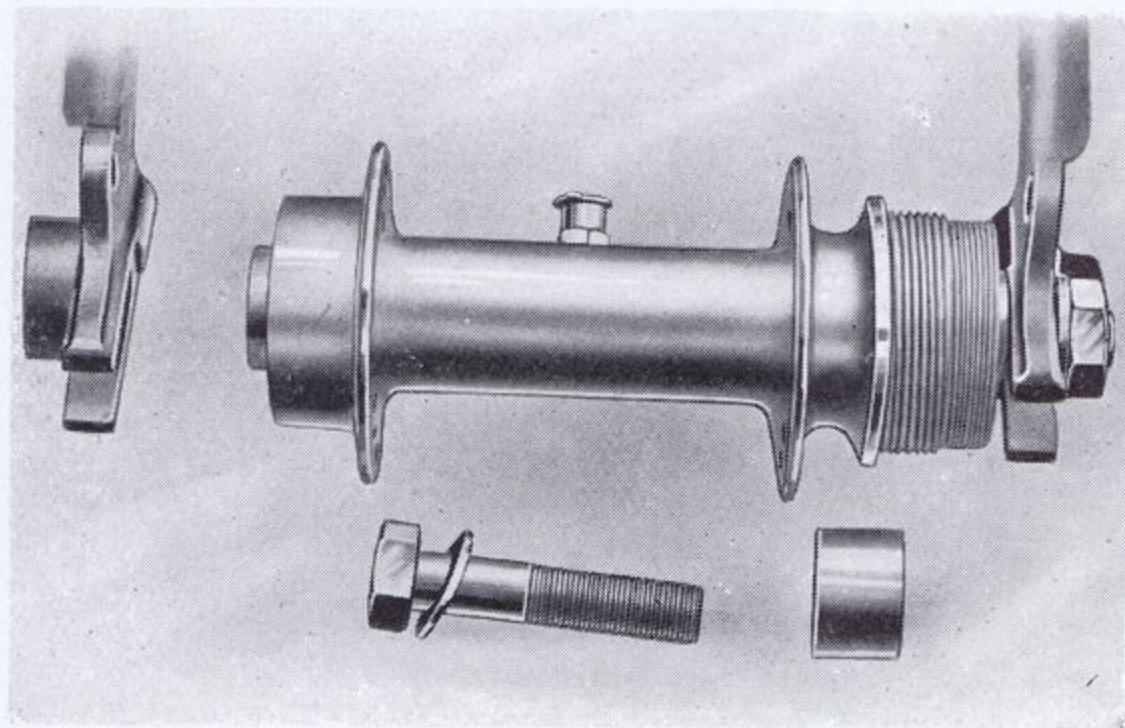

THE SUNBEAM DIVIDED REAR AXLE

from the rear sprocket. The engagement between hub and sprocket is effected by splines and grooves, and these are machined with such accuracy that there is no backlash.

A modification of this principle is adopted on Model 7. On this machine the engagement is effected through pegs on the sprocket which fit into holes on the hub flange. The wheels on Model 7 are interchangeable as well as detachable and can be interchanged with the wheel of sidecars Nos. 1 and 3 or with a spare wheel carried on the sidecar.

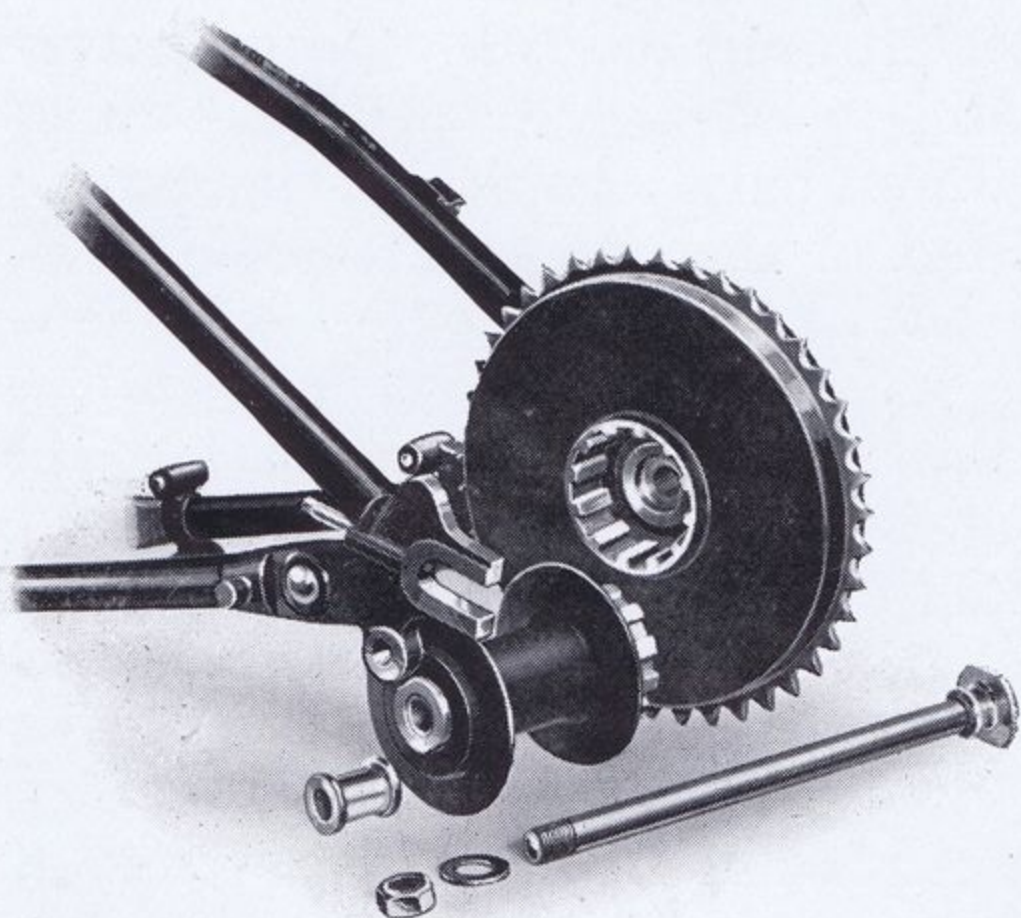

THE SUNBEAM "DROP-OUT" REAR WHEEL

The removal of the wheel or wheels of Model 7, 80 or 90 in no way affects any detail of the transmission or brakes. Adjustment of these remains entirely undisturbed when the wheel is taken out or replaced.

Sunbeams have magnificent

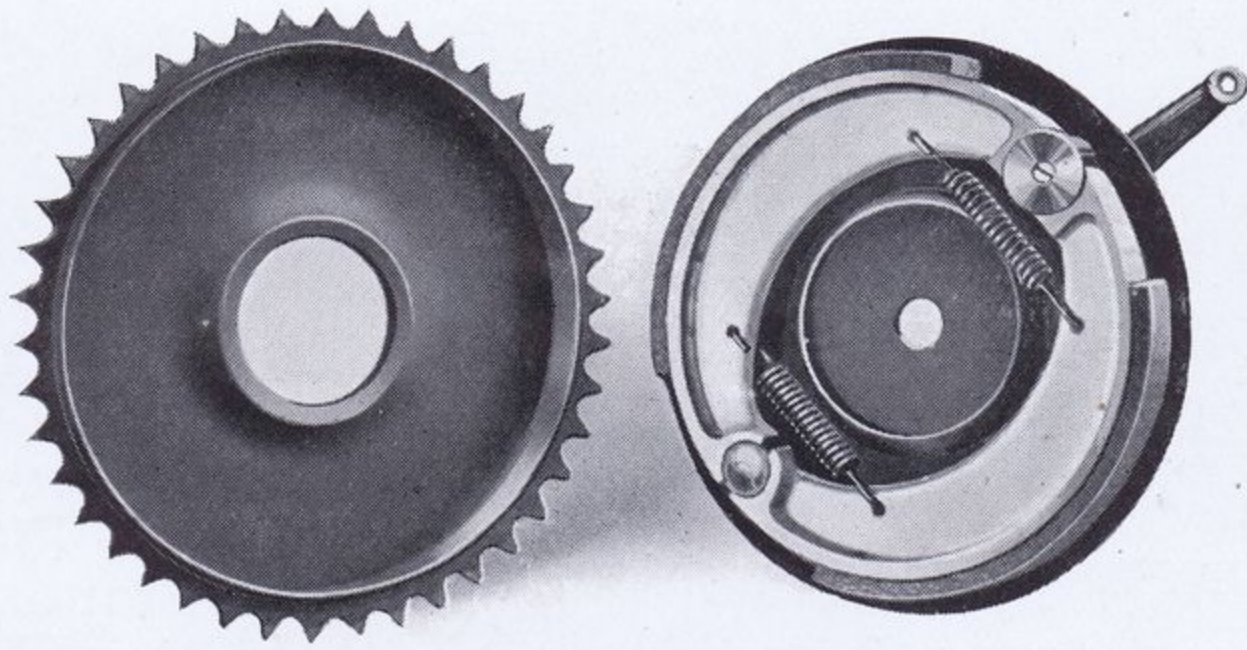

THE SUNBEAM INTERNAL-EXPANDING BRAKES

brakes. On all models they are internal-expanding of Sunbeam design and manufacture. As shown by the illustration above they are extremely simple and have a large braking surface. There is nothing to get out of order and the leverage is so proportioned as to give the maximum braking effect whilst retaining smooth and gradual application.

The Sunbeam patent leaf-spring front fork (Pat. No. 125868), fitted to Model 7 only, is the ideal fork for side-car work. Both road shocks and rebound action are alike

damped out and the front wheel holds the road at all speeds. On the other models we fit the Sunbeam coil-spring fork. On both types the girders are built up as a unit and the bearing pins are adjustable; consequently side play is totally eliminated. Sunbeams as a result are noted for their perfect self-steering. They take a naturally straight line on the open road and can be "held to it" at the most abrupt corner. The bearing surfaces on all Sunbeam front forks are lubricated on the Tecalet grease-gun system, and all

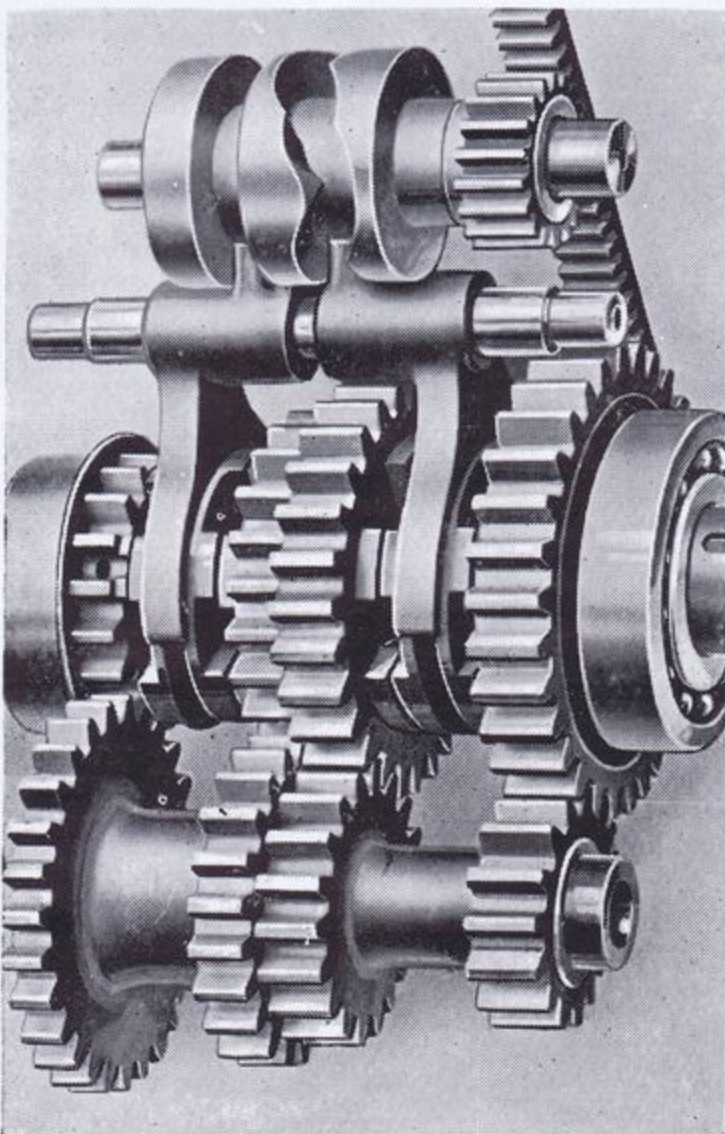

FOUR-SPEED GEAR ON MODEL 7

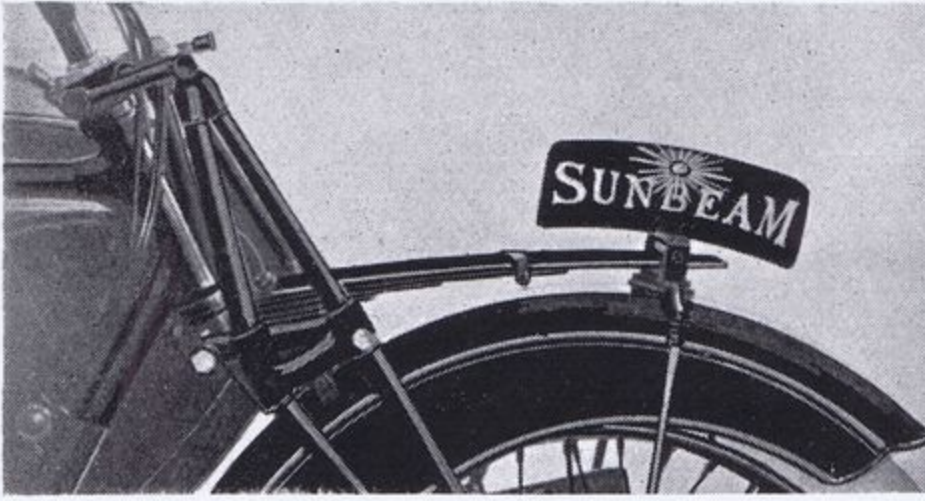

LEAF-SPRING FRONT FORK ON MODEL 7

the changes are effected automatically by the shape of the grooves cut in the cam shown at the top of the illustration. All other Sunbeams have our own ball-bearing three-speed countershaft gearbox operated by a single sliding pinion. It is so designed that in top gear only two pinions are engaged, both middle and low gear pinions coming out of mesh, thus reducing friction. Gear changing on these models is further facilitated by the provision of leather-faced adjustable clutch stops incorporated in the front chaincase, whilst on all Sunbeams the guide plate on the tank has a positive stop at the correct point for engag-

ing each gear and for the free engine position.

On this page is shown an enlarged illustration of the engine fitted to the famous Model 90 Sunbeam. It shows clearly the patent "double hairpin" valve springs (Pat. No. 259870) and the unusually large cooling fins on the double exhaust port. The overhead valve gear of this engine has especially large bearing surfaces, lubricated under pressure on the Tecalmit grease-gun system. The push rods are also grease loaded (Prov. Pat. 15015/26) and the principle of this patent is made quite clear by

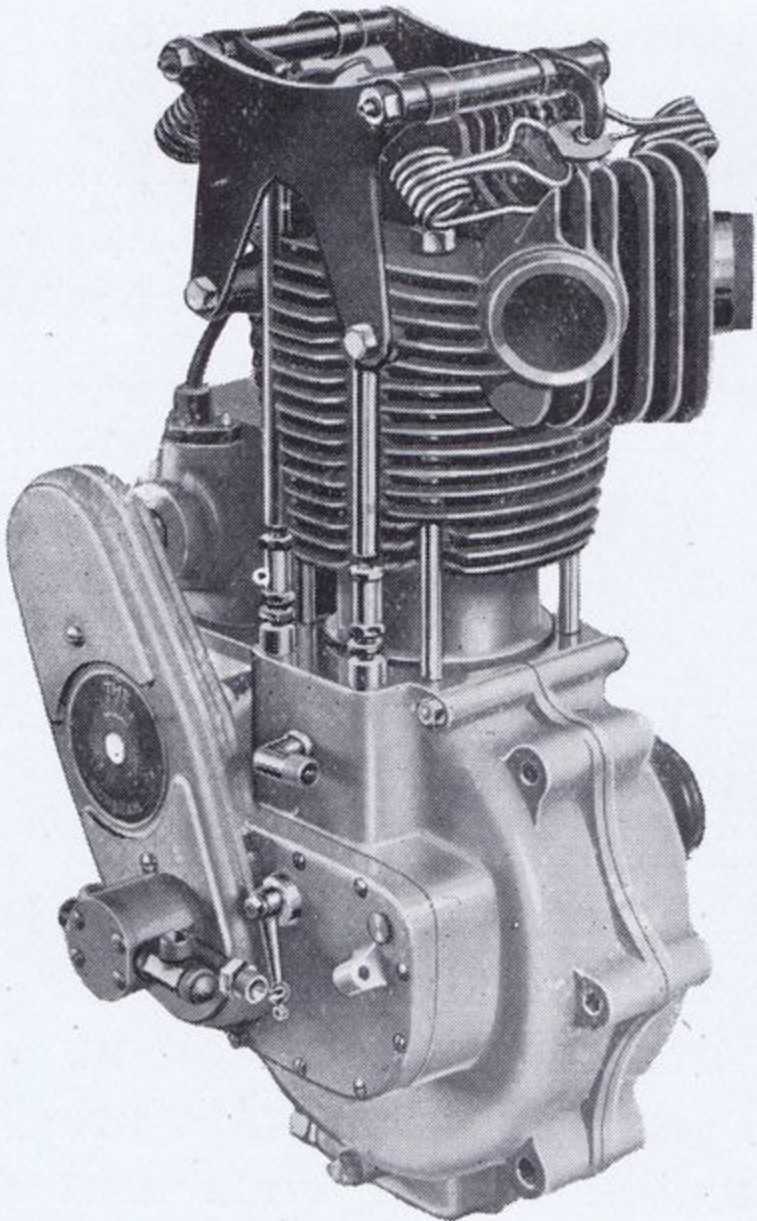

ENGINE OF MODEL 90



THE SUNBEAM STEERING-DAMPER

the diagram on this page. The main lubrication system of this engine is on the dry sump principle, operated by the Sunbeam double mechanical oil pump. The oil is forced under pressure to the patent big-end bearing (Pat. No. 258128) and provision is also made for auxiliary oiling, operated from the handlebars.

Models 80 and 90 are fitted with the extremely simple but efficient steering damper illustrated on this page.

The tension is set by means of the large knob and, of course, can be re-set at any time whilst actually riding. This steering damper can be fitted as an extra to Models 6 and 9 and also to Model 5 when fitted with the Sunbeam underslung handlebars.

The final illustration shows the Sunbeam tool-kit. This deserves special mention. Some of the tools illustrated are used only on certain models and are supplied only with those machines. There are also other tools now supplied, *e.g.* on the O.H.V. Sunbeams, which are not included in the illustration, but on every machine the kit is made up to include all tools necessary to effect every adjustment on that model.

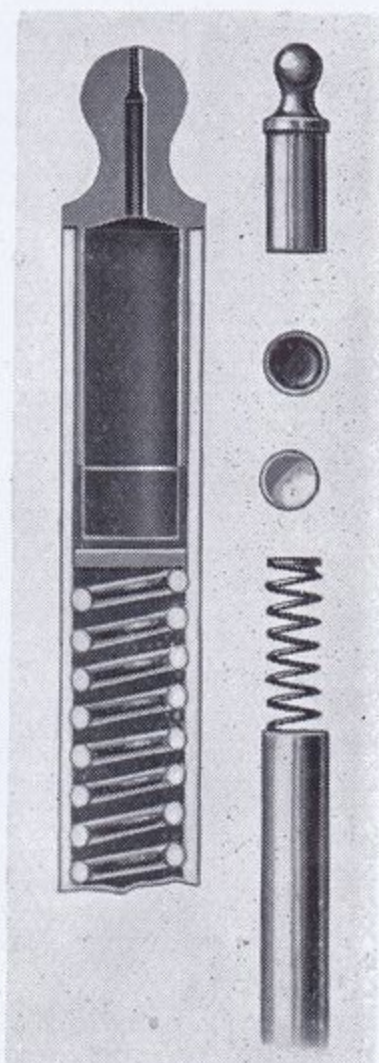

THE SUNBEAM PATENT GREASE LOADED PUSH-ROD

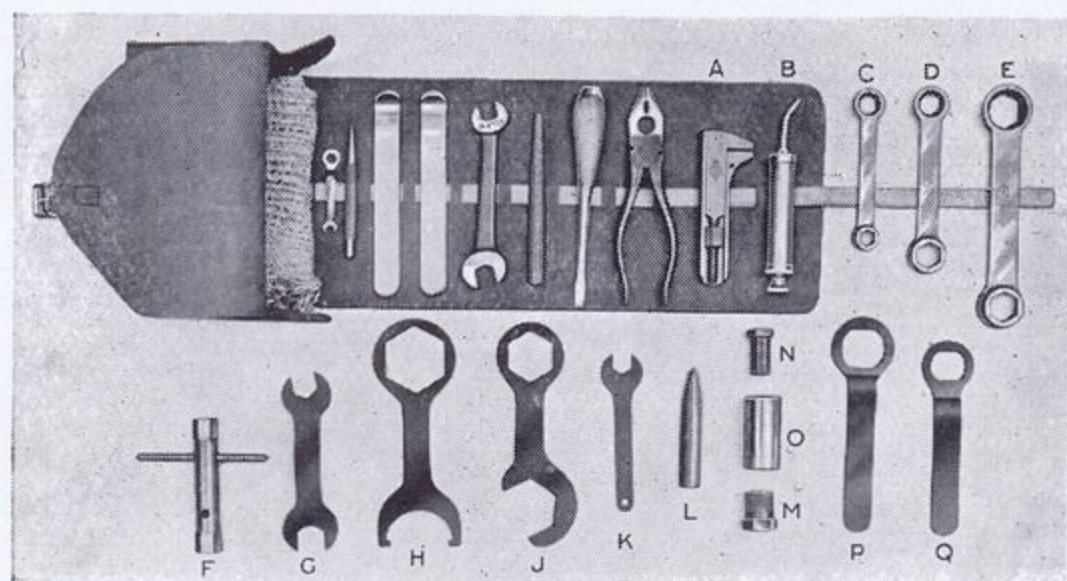

It will be found that Sunbeams at every point provide evidence of the forethought given to the convenience of the rider and ease of maintenance.

Notable SUNBEAM Riders



SUB. LIEUT B. BRYANT, R.N.
Winner of the 1926
Arbuthnot Trophy Trial.



MR N.P.O. BRADLEY.
Best amateur sidecar performance in Scottish Six Days' Trial, and many other successes.



MR T.E. FLINTOFF.
Winner of the 1926
Scott Trial, etc.



MR G.B. GOODMAN.
Winner of the North
Wales Open Challenge
Cup, Robson Shield,
B.N. Bowl, etc., etc.



MR G.C. COBBOLD.
Many racing successes
at Brooklands, etc.



MR ALEC JACKSON.
Winner of Lancashire
"Grand National," etc.



MONS. R. FRANCISQUET.
Winner of 1926 Grand
Prix de France, etc.



HERR O. PUTZ.
Winner of Hungarian Junior
T.T. Race; first amateur in
Grand Prix d'Europe, etc.

Every Land is Sunbeamland

IRELAND.



MR. A.A. WAYTE.
500 c.c. Champion at
10 and 25 miles.

CHANNEL ISLES.



MR. H. WAKEHAM.
Champion of the Channel
Isles (Sand Racing) 1926, etc.



MONS. E. DAMITIO
Winner of the 1926
Bol d'Or.

GERMANY.



HERR. E. LINSER.
Fastest time Saltzberg
Races, and many other
successes.

AUSTRIA.



HERR. R. KARNER.
Winner of Austrian Open
Motor Cycle Derby, etc.



HERR. P. FELEDY.
Winner of the Hungarian
Senior T.T. Race, etc.

SWITZERLAND.



MONS. RUCHE.
Winner of the Neuchatel-Chaumont
Hill Climb, etc., etc.

SWEDEN.



HERR. E. LINDBERG.
A most successful exponent
of ice-racing, etc.

THE SUNBEAM GUARANTEE

WE give the following guarantee with our motor cycles instead of the guarantee implied by statute, or otherwise, as to the quality or fitness of such machines for the purpose of motor cycling; any such implied guarantee being in all cases excluded. In the case of machines which have been used for "hiring out" purposes, or from which our trade mark or manufacturing number has been removed, no guarantee of any kind is given, or is to be implied.

WE GUARANTEE, subject to the conditions mentioned below, that all precautions which are usual and reasonable have been taken by us to secure excellence of materials and workmanship; but this guarantee is to extend and be in force for three months only from the date of purchase, and the damages for which we make ourselves responsible under this guarantee are limited to the replacement of any part which may have proved defective.

WE UNDERTAKE, subject to the conditions mentioned below, to make good at any time within three months any defects in these respects. As motor-cycles are easily liable to derangement by neglect or misuse, this guarantee does not apply to defects caused by wear-and-tear, misuse or neglect.

The term "misuse" shall include, among others, the following acts:—

The attaching of a sidecar to the motor cycle in such manner as to cause damage, or calculated to render the latter unsafe when ridden.

The use of a motor cycle or motor cycle and sidecar combined when carrying more persons or a greater weight than that for which the machine was designed by the manufacturers.

Any motor cycle sent to us to be plated, enamelled, or repaired, whether the repairs are required for the purpose of making good the defect before referred to or otherwise, will be repaired upon the following conditions, i.e. we guarantee that all precautions which are usual and reasonable have been taken by us to secure excellence of material and workmanship, such guarantee to extend and be in force for three months only from the time such work shall have been executed and this guarantee is in lieu and in exclusion of any common law or statute warranty, and the damages recoverable are limited to the cost of any further work which may be necessary to amend and make good the work found to be defective.

CONDITIONS OF GUARANTEE

If a defective part should be found in our motor cycles, or in any part replaced, it must be sent to us, carriage paid, and accompanied by an intimation from the sender that he desires to have it repaired free of charge under our guarantee, and he must also furnish us at the same time with the number of the machine, the name of the agent from whom he purchased it, and the date of the purchase or the date when the alleged defective part was replaced, as the case may be.

Failing compliance with the above, no notice will be taken of anything which may arrive, but such articles will lie here at the risk of the senders, and this guarantee, or any implied guarantee, shall not be enforceable.

We guarantee only those machines which are bought either direct from us or from one of our duly authorised agents, and under no other conditions.

We do not guarantee the specialities of other firms, such as tyres, saddles, chains, lamps, etc., or of any component part supplied to the order of the purchaser differing from our standard specifications, supplied with our motor cycles or otherwise.

THE TERM "AGENT"

is used in a complimentary sense only, and those firms whom we style our agents are not authorised to advertise, incur any debts, or transact any business whatsoever on our account, other than the sale of goods which they may purchase from us; nor are they authorised to give any warranty or make any representation on our behalf other than those contained in the above guarantee.

models. 6. & 9.